

**DIMENSIONS OF  
§ AND § JOINTS**

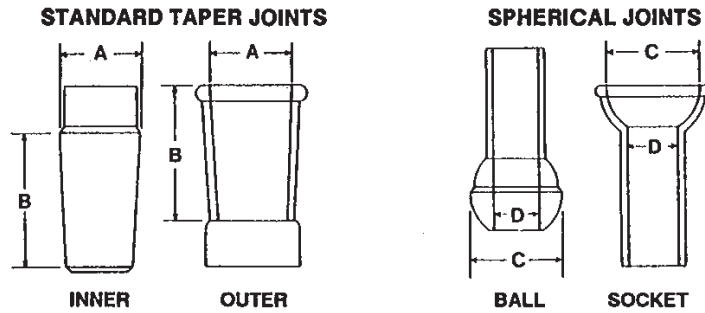

**STANDARD TAPER  
JOINTS**

§ Designation	A Approx. Dia. (mm) Large end of Ground Zone	B Approx. Length (mm) of Joint
7/15	7	15
7/25	7	25
10/18	10	18
10/30	10	30
12/18	12	18
12/30	12	30
14/20	14	20
14/35	14	35
19/22	19	22
19/38	19	38
24/25	24	25
24/40	24	40
29/26	29	26
29/42	29	42
34/28	34	28
34/45	34	45
40/35	40	35
40/50	40	50
45/50	45	50
50/50	50	50
55/50	55	50
60/50	60	50
71/60	71	60
103/60	103	60
145/60	145	60

**SPHERICAL JOINTS  
BALL & SOCKET**

§ Designation	C Approx. Dia. (mm) of Ground Ball	D Approx. I.D. (mm) of Joint
12/1	12	1
12/2	12	2
12/3	12	3
12/5	12	5
18/7	18	7
18/9	18	9
28/12	28	12
28/15	28	15
35/20	35	20
35/25	35	25
40/25	40	25
50/30	50	30
65/40	65	40
75/50	75	50
102/75	102	75

## 155050

ADAPTER, BUSHING-TYPE,  $\text{K}$  JOINTS. With heavy walls for added strength. Top rim allows a firm grip for removing from apparatus.

Code	Inner (Outside)	Outer (Inside)	Code	Inner (Outside)	Outer (Inside)
-01	14/35	10/30	-16	40/50	34/45
-02	19/38	10/30	-17	45/50	24/40
-03	19/38	14/35	-18	45/50	29/42
-04	24/40	10/30	-19	45/50	34/45
-05	24/40	14/35	-20	45/50	40/50
-06	24/40	19/38	-21	50/50	34/45
-07	29/42	10/30	-22	50/50	45/50
-08	29/42	14/35	-23	55/50	29/42
-09	29/42	19/38	-24	55/50	34/45
-10	29/42	24/40	-25	55/50	45/50
-11	34/45	19/38	-26	55/50	50/50
-12	34/45	24/40			
-13	34/45	29/42			
-14	40/50	24/40			
-15	40/50	29/42			

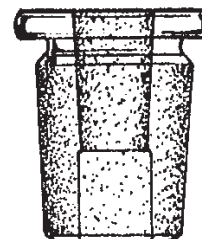

155050

## 155060

ADAPTER, REDUCING AND ENLARGING.  $\text{K}$  joints. Please order by code number or specify  $\text{K}$  or  $\text{S}$  joint sizes desired.

Code	Inner	Outer	Code	Inner	Outer
-01	10/30	14/20	-21	24/40	45/50
-02	10/30	19/22	-22	24/40	55/50
-03	10/30	24/40	-23	29/42	14/35
-04	12/30	24/40	-24	29/42	10/30
-05	14/20	10/30	-25	29/42	24/40
-06	14/20	19/22	-26	29/42	55/50
-07	14/20	24/20	-27	34/45	24/40
-08	14/20	29/42	-28	40/50	24/40
-09	14/35	24/40	-29	45/50	24/40
-10	14/35	29/42	-30	45/50	29/42
-11	19/22	10/30	-31	45/50	34/45
-12	19/22	14/20	-32	45/50	55/50
-13	19/22	24/40	-33	50/50	24/40
-14	19/22	29/42	-34	50/50	55/50
-15	24/40	10/30	-35	55/50	24/40
-16	24/40	14/20	-36	55/50	29/42
-17	24/40	14/35	-37	55/50	34/45
-18	24/40	19/22	-38	55/50	45/50
-19	24/40	29/42	-39	60/50	24/40
-20	24/40	34/45	-40	71/60	24/40



155060

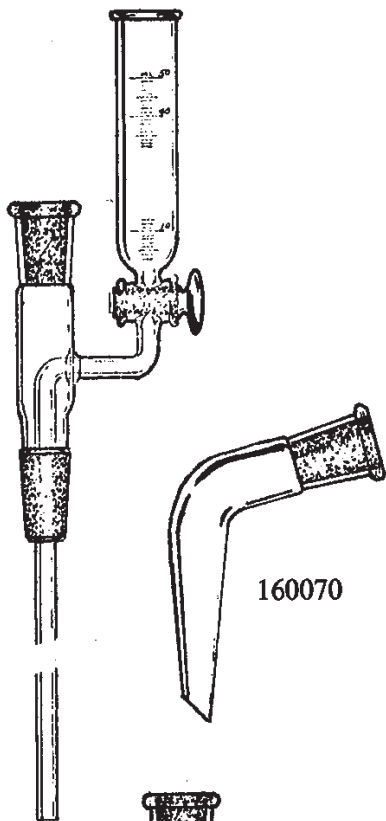

160010

### 160010

ADAPTER, ADDITION-TYPE. With a 50 ml capacity funnel and ground joints. Lower tube extends 180 mm below bottom joint. Please order by code number or specify  $\mathbb{F}$  or  $\mathbb{S}$  joint size desired.

CODE	SIZE
-01	24/40 with 2 mm Glass stopcock
-02	24/40 with 2 mm Teflon stopcock

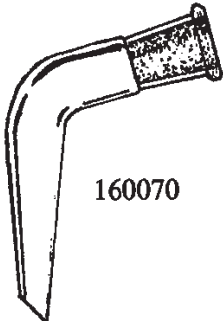

160070

### 160070

ADAPTER. 105° angle and drip tip. Please order by code number or specify  $\mathbb{F}$  or  $\mathbb{S}$  joint size desired.

CODE	SIZE
-01	24/40

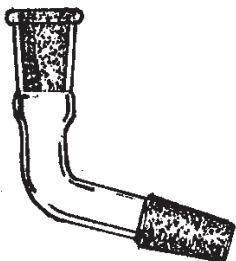

160080

### 160080

ADAPTER. 105° angle, with  $\mathbb{F}$  inner or  $\mathbb{S}$  ball joint on one end and  $\mathbb{F}$  outer or  $\mathbb{S}$  socket joint on other end. Please order by code number or specify  $\mathbb{F}$  or  $\mathbb{S}$  joint size desired.

CODE	SIZE
-01	24/40

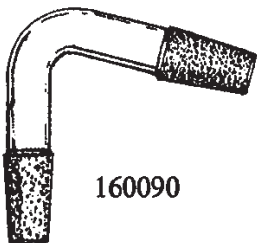

160090

### 160090

ADAPTER. 75° angle, with  $\mathbb{F}$  inner or  $\mathbb{S}$  ball joints at both ends. Please order by code number or specify  $\mathbb{F}$  or  $\mathbb{S}$  joint size desired.

CODE	SIZE
-01	24/40



160095

### 160095

ADAPTER, CONNECTING-TYPE. For extending apparatus assemblies. Please order by code number or specify  $\mathbb{F}$  or  $\mathbb{S}$  joint size desired and length desired between joints. If length not specified 100 mm length will be supplied.

CODE	SIZE
-01	24/40

## 160105

ADAPTER, CLAISEN. With  $\text{K}$  inner or  $\text{S}$  ball joint at bottom and  $\text{K}$  outer or  $\text{S}$  socket joint at top of side tube, and with a #7 Ace-Thread with nylon bushing and o-ring for adjustable length thermometer.

CODE	SIZE
------	------

-01	24/40
-----	-------

## 160130

ADAPTER, CLAISEN. With  $\text{K}$  inner or  $\text{S}$  ball joint at bottom and  $\text{K}$  outer or  $\text{S}$  socket joint at top of side tube, and with  $\text{K}$  10/30 outer joint at top of main tube for 75 mm thermometer immersion. Please order by code number or specify  $\text{K}$  or  $\text{S}$  joint size desired.

CODE	SIZE
------	------

-01	24/40
-----	-------

## 160140

ADAPTER, CLAISEN. With  $\text{K}$  inner or  $\text{S}$  ball joint at bottom and  $\text{K}$  outer or  $\text{S}$  socket joints at top. Please order by code number or specify  $\text{K}$  or  $\text{S}$  joint size desired.

CODE	SIZE
------	------

-01	24/40
-----	-------

## 160180

ADAPTER, CLAISEN. With  $\text{K}$  inner or  $\text{S}$  ball joints on bottom and side,  $\text{K}$  outer or  $\text{S}$  socket joint at top of main tube and  $\text{K}$  10/30 outer joint at top of side tube for 75 mm thermometer immersion. Please order by code number or specify  $\text{K}$  or  $\text{S}$  joint size desired.

CODE	SIZE
------	------

-01	24/40
-----	-------

## 160190

ADAPTER, CLAISEN. With  $\text{K}$  inner or  $\text{S}$  ball joints at bottom and side and  $\text{K}$  10/30 outer joints at top of main tube and top of side tube. Side tube is modified for vacuum connection with hose connection. Please order by code number or specify  $\text{K}$  or  $\text{S}$  joint size desired.

CODE	SIZE
------	------

-01	24/40
-----	-------

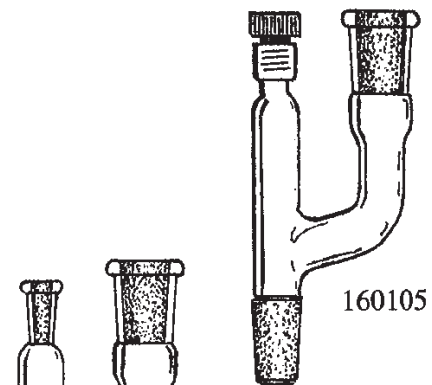

160105

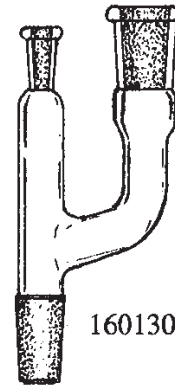

160130

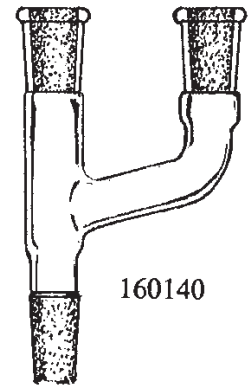

160140

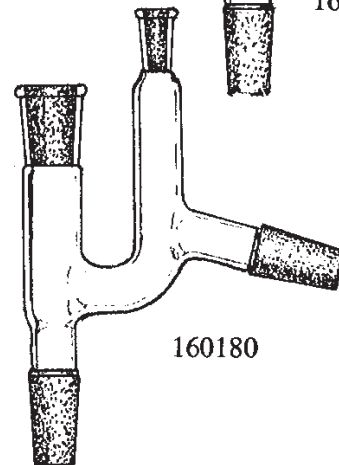

160180

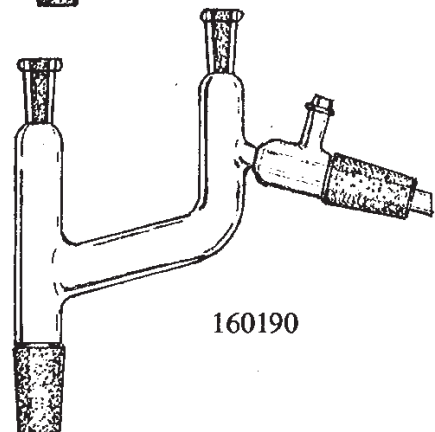

160190

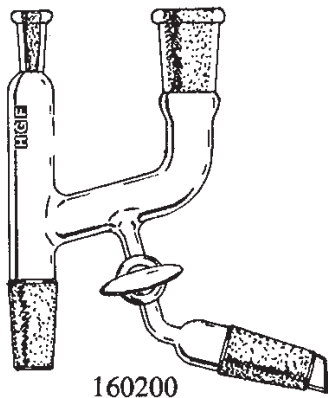

### 160200

ADAPTER, CLAISEN. With  $\text{F}$  inner or  $\text{S}$  ball joints at bottom,  $\text{F}$  outer or  $\text{S}$  socket joint at top of side tube,  $\text{F}$  10/30 outer joint at top of main tube for 75 mm thermometer immersion and with  $\text{F}$  2 mm stopcock on lower side tube. Please order by code number or specify  $\text{F}$  or  $\text{S}$  joint size desired.

CODE	SIZE
-01	24/40 with 2 mm Glass stopcock
-02	24/40 with 2 mm Teflon stopcock

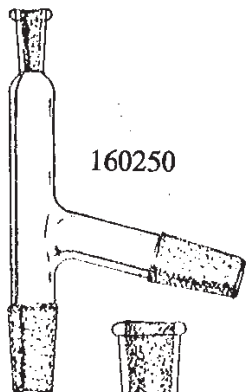

### 160250

ADAPTER, CONNECTING. With  $\text{F}$  inner or  $\text{S}$  ball joints on 75° angle and with  $\text{F}$  10/30 outer joint at top for 75 mm thermometer immersion. Please order by code number or specify  $\text{F}$  or  $\text{S}$  joint size desired.

CODE	SIZE
-01	24/40

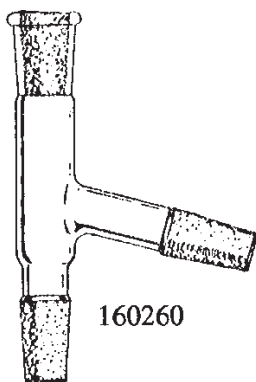

### 160260

ADAPTER, CONNECTING. With  $\text{F}$  inner or  $\text{S}$  ball joints on 75° angle and with  $\text{F}$  outer or  $\text{S}$  socket joint at top. Please order by code number or specify  $\text{F}$  or  $\text{S}$  joint size desired.

CODE	SIZE
-01	24/40

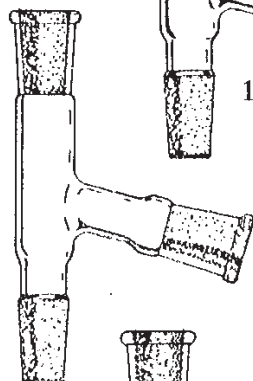

### 160270

ADAPTER, CONNECTING. With  $\text{F}$  outer or  $\text{S}$  socket joints on 105° angle and with  $\text{F}$  outer or  $\text{S}$  socket joint at top. Please order by code number or specify  $\text{F}$  or  $\text{S}$  joint size desired.

CODE	SIZE
-01	24/40

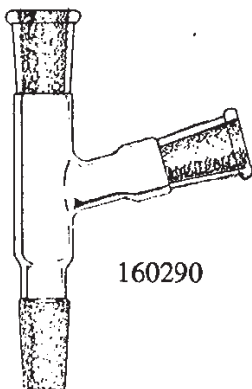

### 160290

ADAPTER, CONNECTING. With  $\text{F}$  outer or  $\text{S}$  socket joints at 75° angle and with  $\text{F}$  inner or  $\text{S}$  ball joint at bottom. Please order by code number or specify  $\text{F}$  or  $\text{S}$  joint size desired.

CODE	SIZE
-01	24/40

### 160300

ADAPTER, CONNECTING. With parallel ⌘ inner or ⌘ ball joints. Joints are 200 mm apart and are set at 75° and 105° respectively. Please order by code number or specify ⌘ or ⌘ joint size desired.

CODE	SIZE
------	------

-01	24/40
-----	-------

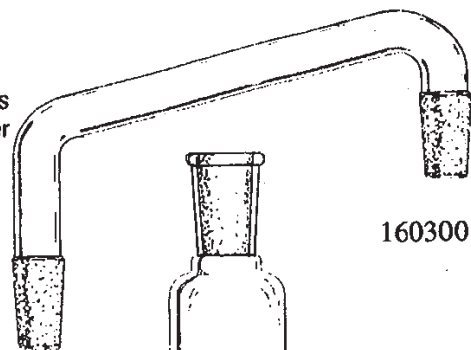

### 160310

ADAPTER, DISTILLATE COLLECTOR. With ⌘ or ⌘ joints and with side tube at 75° angle. (ASTM D-1839). Please order by code number or specify ⌘ of ⌘ joint size desired.

CODE	SIZE
------	------

-01	24/40
-----	-------

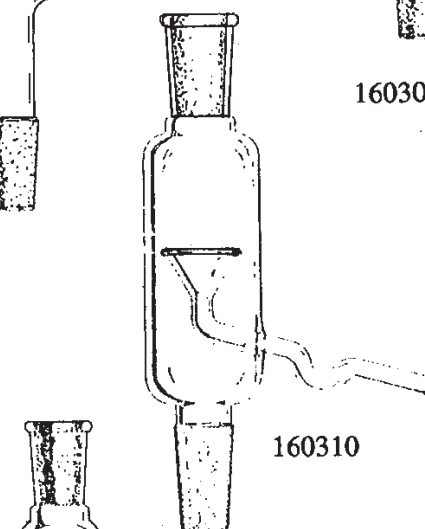

### 160320

ADAPTER, DISTILLATE COLLECTOR. With ⌘ 2 mm T-bore stopcock on side tube at 75° angle to permit removal of condensate as product or returning of condensate as reflux. With ⌘ outer or ⌘ socket joint at top and inner or ⌘ ball joint at bottom. Please order by code number or specify ⌘ or ⌘ joint size desired.

CODE	SIZE
------	------

-01	24/40 with 2 mm Glass stopcock
-02	24/40 with 2 mm Teflon stopcock

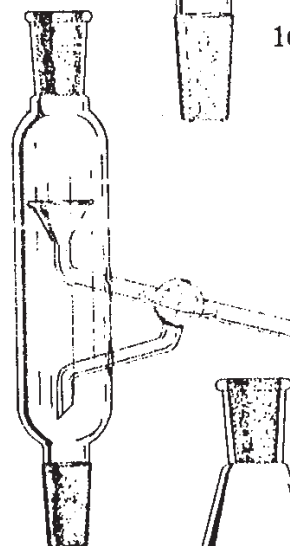

### 160325

ADAPTER, DISTILLATE COLLECTOR. With ⌘ outer or ⌘ socket joint at top and ⌘ inner or ⌘ ball joint at bottom, and with ⌘ 2 mm stopcock connected to apron for removing distillate. Please order by code number or specify ⌘ or ⌘ joint size desired.

CODE	SIZE
------	------

-01	24/40 with 2 mm Glass stopcock
-02	24/40 with 2 mm Teflon stopcock

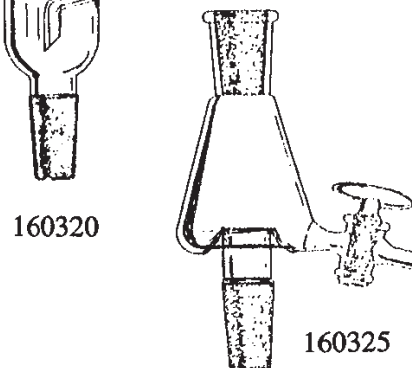

### 160330

ADAPTER, DISTILLING. With ⌘ inner or ⌘ ball joint and with 150 mm long sidearm at 75° angle. Please order by code number or specify ⌘ or ⌘ joint size desired.

CODE	SIZE
------	------

-01	24/40
-----	-------

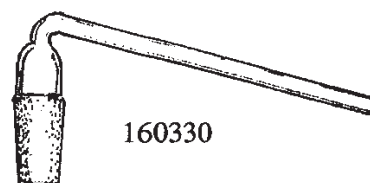

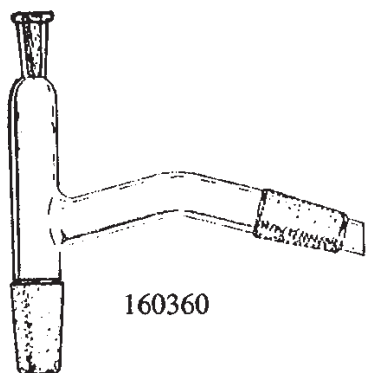

160360

### 160360

ADAPTER, DISTILLING. With  $\text{K}$  inner or  $\text{J}$  ball joints at bottom and on side at 75° angle, and with  $\text{K}$  10/30 outer joint at top for 75 mm thermometer immersion. Please order by code number or specify  $\text{K}$  or  $\text{J}$  joint size desired.

CODE	SIZE
------	------

-01	24/40
-----	-------

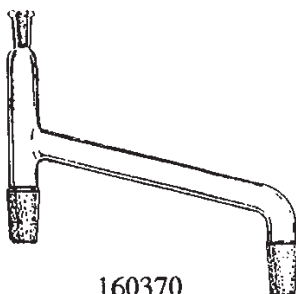

160370

### 160370

ADAPTER, DISTILLING. With  $\text{K}$  inner or  $\text{J}$  ball joints parallel at bottom, and with  $\text{K}$  10/30 outer joint at top for 75 mm thermometer immersion. Sidearm is set at 75° angle. Please order by code number or specify  $\text{K}$  or  $\text{J}$  joint desired.

CODE	SIZE
------	------

-01	24/40
-----	-------

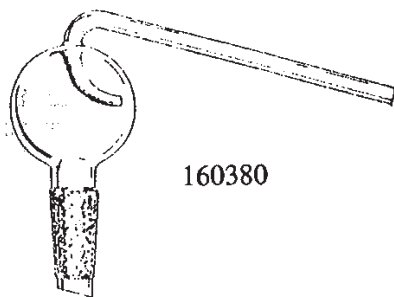

160380

### 160380

ADAPTER, DISTILLING. With trap and  $\text{K}$  inner or  $\text{J}$  ball joint. Outlet tube is set at 75° angle. Please order by code number or specify  $\text{K}$  or  $\text{J}$  joint size desired.

CODE	SIZE
------	------

-01	24/40
-----	-------

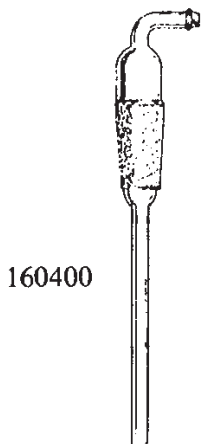

160400

### 160400

ADAPTER, GAS INLET. With  $\text{K}$  inner or ball joint and hose connection. Please order by code number or specify  $\text{K}$  or  $\text{J}$  joint size and length of lower tube below joint desired. If length is not specified, 180 mm length will be supplied.

CODE	SIZE
------	------

-01	24/40
-----	-------

### 160450

ADAPTER, GAS INLET. With  $\text{K}$  inner or  $\text{S}$  ball joint and hose connections for gas inlet and outlet at side. Please order by code number or specify  $\text{K}$  or  $\text{S}$  joint size and length of lower tube desired. If length is not specified, 180 mm will be supplied.

CODE	SIZE
------	------

-01	24/40
-----	-------

### 160460

ADAPTER, GAS OUTLET. With  $\text{K}$  inner  $\text{S}$  ball joint and hose connection bent at 90°. Please order by code number or specify  $\text{K}$  or  $\text{S}$  joint desired.

CODE	SIZE
------	------

-01	24/40
-----	-------

### 160470

ADAPTER, GAS INLET. With  $\text{K}$  or  $\text{S}$  ground joints and hose connection for gas inlet at side. Please order by code number or specify  $\text{K}$  or  $\text{S}$  joint size and length of lower tube below joint desired. If length not specified, 180 mm length will be supplied.

CODE	SIZE
------	------

-01	24/40
-----	-------

### 160490

ADAPTER, HOSE CONNECTOR. With  $\text{K}$  inner or  $\text{S}$  ball joint, 2 mm stopcock and hose connection bent at 90°. Please order by code number or specify  $\text{K}$  or  $\text{S}$  joint size desired.

CODE	SIZE
------	------

-01	24/40 with 2 mm Glass stopcock
-02	24/40 with 2 mm Teflon stopcock

### 160495

ADAPTER, HOSE CONNECTOR. With  $\text{K}$  inner or  $\text{S}$  ball joint and hose connection. Please specify  $\text{K}$  or  $\text{S}$  joint size desired.

CODE	SIZE
------	------

-01	24/40
-----	-------

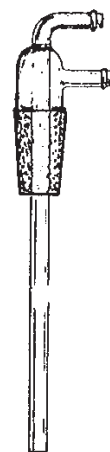

160450

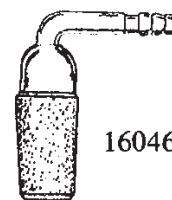

160460

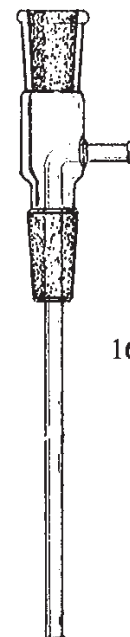

160470



160490



160495



160500

### 160500

ADAPTER, HOSE CONNECTOR. With  $\text{K}$  outer or  $\text{S}$  socket joint and hose connection bent at 90°. Please order by code number or specify  $\text{K}$  or  $\text{S}$  joint size desired.

CODE	SIZE
-01	24/40

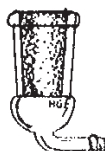

160505

### 160505

ADAPTER, HOSE CONNECTOR. With  $\text{K}$  outer or  $\text{S}$  socket joint and hose connection. Please order by code number or specify  $\text{K}$  or  $\text{S}$  joint size desired.

CODE	SIZE
-01	24/40

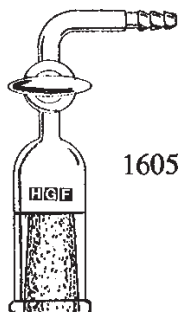

160510

### 160510

ADAPTER, HOSE CONNECTOR. With  $\text{K}$  outer or  $\text{S}$  socket joint and 2 mm stopcock. With hose connection bent 90°. Please order by code number or specify  $\text{K}$  or  $\text{S}$  joint size desired.

CODE	SIZE
-01	24/40 with 2 mm Glass stopcock
-02	24/40 with 2 mm Teflon stopcock

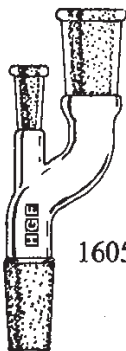

160540

### 160540

ADAPTER, OFFSET. With  $\text{K}$  10/30 outer joint for 75 mm thermometer immersion at top of main tube, and with  $\text{K}$  or  $\text{S}$  joints at top and bottom. Please order by code number or specify  $\text{K}$  or  $\text{S}$  joint size desired.

CODE	SIZE
-01	24/40



160570

### 160570

ADAPTER, STOPCOCK OUTLET. With  $\text{K}$  outer or  $\text{S}$  socket joint and  $\text{K}$  2 mm stopcock and hose connection. Please order by code number or specify  $\text{K}$  or  $\text{S}$  joint size desired.

CODE	SIZE
-01	24/40 with 2 mm Glass stopcock
-02	24/40 with 2 mm Teflon stopcock

### 160575

ADAPTER, HIGH-VACUUM. With  $\text{K}$  inner or  $\text{J}$  ball joint and 0-4 mm High-Vacuum teflon valve. Please order by code number or specify  $\text{K}$  or  $\text{J}$  joint size desired.

CODE	SIZE
------	------

-01	24/40 stopcock with Viton o-rings
-02	24/40 stopcock with Teflon o-rings

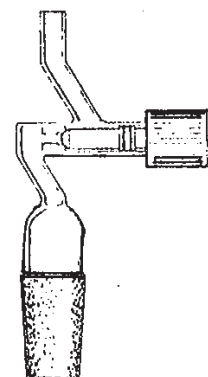

160575

### 160580

ADAPTER, STRAIGHT, With  $\text{K}$  outer or  $\text{J}$  socket joint at top and reduced lower tube cut at angle. Please order by code number or specify  $\text{K}$  or  $\text{J}$  joint size desired.

CODE	SIZE
------	------

-01	24/40
-----	-------



160580

### 160620

ADAPTER, STRAIGHT, WITH TRAP. With  $\text{K}$  or  $\text{J}$  ground joints and with distillation trap. Please order by code number or specify  $\text{K}$  or  $\text{J}$  joint size desired.

CODE	SIZE
------	------

-01	24/40
-----	-------



160620

### 160640

ADAPTER, THERMOMETER. With inner joint at bottom and  $\text{K}$  10/30 outer joint at top, off-set and inclined from the vertical to permit thermometer positioning at convenient points in flask. With hose connection, to combine thermometer positioning and gas or vacuum connection. Please order by code number or specify  $\text{K}$  or  $\text{J}$  joint size desired.

CODE	SIZE
------	------

-01	24/40
-----	-------



160640

### 160660

ADAPTER, THERMOMETER WELL. With  $\text{K}$  inner or  $\text{J}$  ball joint and round-bottomed lower tube. Top has reinforcing bead. Please order by code number or specify  $\text{K}$  or  $\text{J}$  joint size and length of lower tube desired. If length not specified, 150 mm length will be supplied.

CODE	SIZE
------	------

-01	24/40
-----	-------



160660

## 170000

BOTTLES, SINGLE NECK. Please order by code number or specify capacity and  $\text{K}$  joint size desired.

CODE	CAPACITY(ML)	JT SIZE
------	--------------	---------

-01	250	24/40
-02	500	24/40
-03	1000	24/40
-04	2000	24/40
-05	2000	29/42
-06	5000	24/40
-07	5000	29/42
-08	10000	45/50

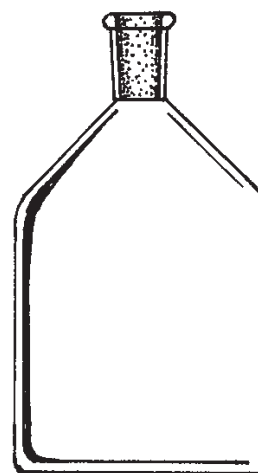

170000

FOR STOPPERS SEE PART #521100.

## 170260

BOTTLE, GAS WASHING. With 20 mm fritted disc attached to bottom of inlet tube. Ground joint is  $\text{K}$  40/50. "EC" porosity disc will be supplied unless another porosity is specified. Please order by code number.

CODE	CAPACITY(ML)	DESCRIPTION
------	--------------	-------------

-01	125	COMPLETE
-01P1		Top Only
-01P2		Bottom Only
-02	250	COMPLETE
-02P1		Top Only
-02P2		Bottom Only
-03	500	COMPLETE
-03P1		Top Only
-03P2		Bottom Only

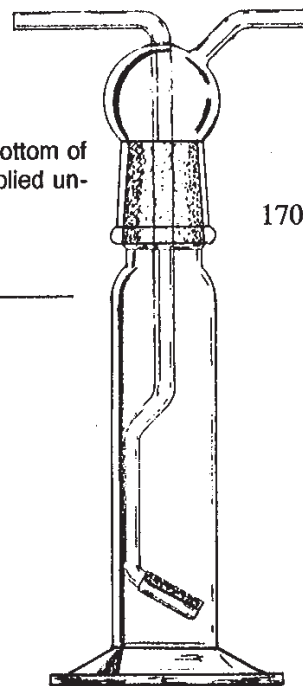

170260

## 170300

BOTTLE, GAS WASHING. With  $\text{K}$  24/40 joint and 20 mm fritted disc attached to the bottom of the inlet tube. "EC" porosity will be supplied unless another porosity is specified. Please order by code number.

CODE	CAPACITY(ML)
------	--------------

-01	125
-02	250
-03	500
-04	1000

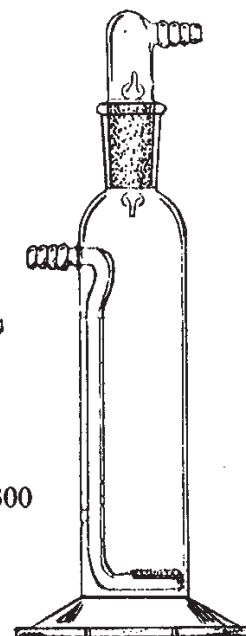

170300

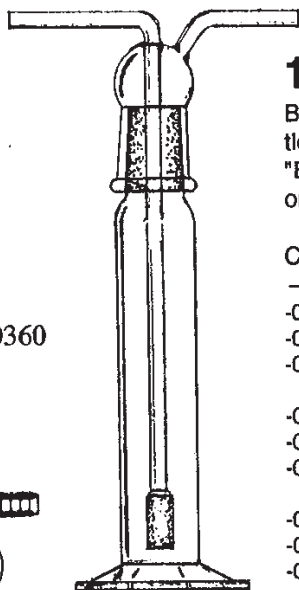

170360

### 170360

BOTTLE, GAS WASHING, TALL FORM. Our most popular gas wash bottle. With  $\frac{3}{8}$  29/42 stopper top and with dispersion tube at end of inlet tube. "EC" porosity will be supplied unless another porosity is specified. Please order by code number.

CODE      CAPACITY(ML)      DESCRIPTION

-01	125	COMPLETE
-01P1		Top Only
-01P2		Bottom Only
-02	250	COMPLETE
-02P1		Top Only
-02P2		Bottom Only
-03	500	COMPLETE
-03P1		Top Only
-03P2		Bottom Only

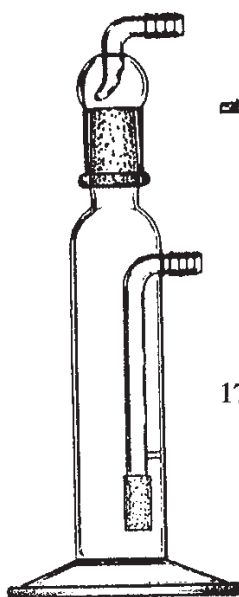

170368

### 170368

BOTTLE, GAS WASHING, IMPROVED. Gas inlet tube is solidly sealed inside the bottle, eliminating accidental breakage when cap is removed. Joint is  $\frac{3}{8}$  29/42. "EC" porosity fritted dispersion tube will be supplied unless another porosity is specified.

CODE      CAPACITY(ML)      DESCRIPTION

-01	125	COMPLETE
-02	250	COMPLETE
-03	500	COMPLETE

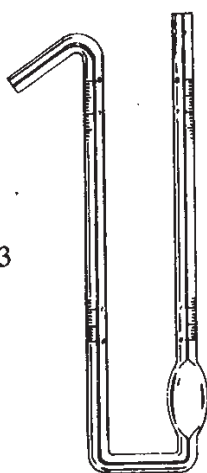

171793

### 171793

BOTTLE, SPECIFIC GRAVITY, PYCNOMETER: Tube for measuring the density of volatile liquids. Graduated 0-8 cm in 1 mm increments on both arms. Ref. ASTM D-941.

CODE      BULB CAPACITY(ML)

-01	0.5
-02	1.0
-03	2.0
-04	3.0
-05	4.5
-06	5.0
-07	10.0

## 178050

BUBBLER, MIDGET. An efficient gas sampler, forcing the gas to stream into thousands of tiny bubbles to permit efficient absorption by the impinging liquid. Joint is  $\frac{3}{4}$ " and porosity of dispersion tube is "C".

CODE	PARTS
-00	COMPLETE
-01	Top only, with dispersion tube
-02	Bottom only, graduated



178050

## 310500

IMPINGER, MIDGET. The orifice at the bottom of the impinger tube passes .09-.11 CFM of air at 12" H<sub>2</sub>O. Designed for sampling of small air volumes with a low jet velocity. The bottle portion is graduated from 5 to 30 ml. Adaptable to any air sample that runs at a steady 0.1 CFM flow rate. Ground joint is  $\frac{3}{4}$ ".

CODE	PARTS
-00	COMPLETE
-01	Impinger tube only, with $\frac{3}{4}$ " inner joint
-02	Bottle only, with $\frac{3}{4}$ " outer joint



310500

## 310510

IMPINGER, MIDGET, with  $\frac{3}{8}$ " joints. Identical to 310500, except with  $\frac{3}{8}$ " 12/5 ball joints on inlet and outlet.

CODE	PARTS
-00	COMPLETE
-01	Impinger tube only, with $\frac{3}{4}$ " inner joint
-02	Bottle only, with $\frac{3}{4}$ " outer joint



310510

## 178550

BULB, GAILLARD, Gas weighing. Volume of bulb is approximately 500 ml, joint is  $\frac{3}{4}$ " and stopcock is 2 mm bore with capillary arm.

CODE	PARTS
-00	COMPLETE
-01	Top only, with stopcock
-02	Bulb only

178550

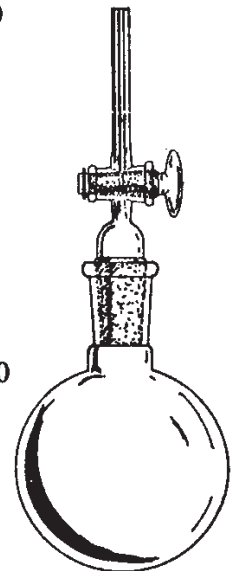



180050

### 180050

BURET, STRAIGHT. Laboratory grade buret with Teflon stopcock.

CODE	CAPACITY(ML)	DIV.(ML)
-01	10	1/20
-02	25	1/10
-03	50	1/10
-04	100	1/5



180070

### 180070

BURET, AUTOMATIC ZERO. Laboratory grade buret with Teflon 3-way stopcock and automatic zero and overflow tube.

CODE	CAPACITY(ML)	DIV.(ML)
-01	10	1/20
-02	25	1/10
-03	50	1/10
-04	100	1/5



180130

### 180100

BURET, DISPENSING. Laboratory grade buret with large bore Teflon stopcock.

CODE	CAPACITY (ML)	DIV. (ML)
-01	250	1
-02	500	5
-03	1000	10
-04	2000	10
-05	4000	25

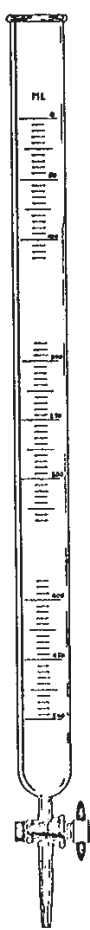

180100

### 180130

BURET, MICRO, PRECISION. Precision grade buret with funnel top and glass stopcock.

CODE	CAPACITY (ML)	DIV. (ML)
-01	1	1/100
-02	2	1/100
-03	5	1/50

## 180140

BURET, MICRO, PRECISION. Similar to 180130, except with Teflon stopcock.

CODE	CAPACITY (ML)	DIV. (ML)
-01	1	1/100
-02	2	1/100
-03	5	1/50

## 180160

BURET, MICRO, PRECISION. Precision grade buret with 3-way Teflon stopcock.

CODE	CAPACITY (ML)	DIV. (ML)
-01	1	1/100
-02	2	1/100
-03	5	1/50
-04	10	1/50

## 180165

BURET, MODIFIED, MCA-4, JACKETED. Similar to the standard MCA-4 buret, except with Teflon stopcock and with a cylindrical water jacket. When filled with water, the jacket acts to magnify the graduation marks on the buret, resulting in much more accurate readings.

CODE	CAPY (ML)	UPPER BULB (ML)	GRAD.TUBE(ML)
-01	75	50	50 - 75 X 1/10
-02	100	75	75 - 100 X 1/10
-03	100 (M)	50	50 - 100 X 1/10

## 180180

BURET, AUTOMATIC, PRECISION. Precision grade automatic buret for use with either acids or alkalis with Teflon stopcock. Supplied complete with reservoir bottle and drying tubes.

CODE	CAPACITY (ML)	DIV. (ML)	BOTTLE (ML)
-01	2	1/50	1000
-02	5	1/20	1000
-03	10	1/20	1000
-04	25	1/10	1000
-05	50	1/10	2000
-06	100	1/5	4000



180165

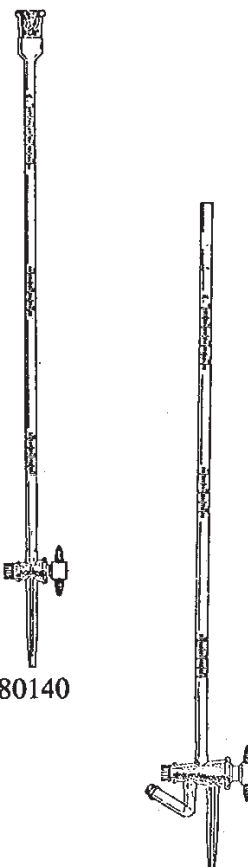

180140



180160

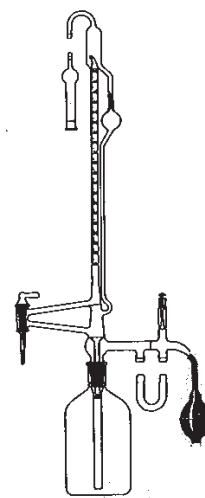

180180

## 180190

BURET, ACID. Automatic-type buret designed to fit standard screw-cap reagent bottles. With  $\frac{3}{4}$  stopcock, plastic cap assembly, and rubber bulb, but without bottle.

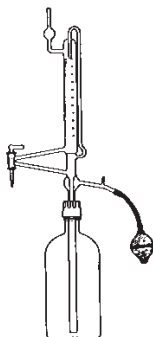

180190

180195

CODE	CAPACITY (ML)	DIV. (ML)
------	---------------	-----------

-01	50	1
-02	100	1
-03	250	5

180190-CA	Cap Assembly Only
180190-RB	Rubber Bulb Only

## 180195

BURET, ACID. Similar to 180190, but with Teflon stopcock.

CODE	CAPACITY (ML)	DIV. (ML)
------	---------------	-----------

-01	50	1
-02	100	1
-03	250	5

180190-CA	Cap Assembly Only
180190-RB	Rubber Bulb Only

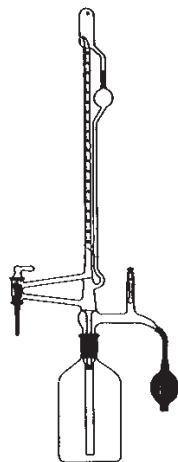

180200

## 180200

BURET, AUTOMATIC. Laboratory grade automatic buret with  $\frac{3}{4}$  glass stopcock and reservoir bottle.

CODE	DESCRIPTION
------	-------------

-01	10 ml x 1/20 ml div. Complete with 1000 ml bottle, 24/40
-01P1	10 ml Buret only
-01P2	1000 ml Bottle only, 24/40

-02	25 ml x 1/10 ml div. Complete with 1000 ml bottle, 24/40
-02P1	25 ml Buret only
-02P2	1000 ml Bottle only, 24/40

-03	50 ml x 1/10 ml div. Complete with 2000 ml bottle, 24/40
-03P1	50 ml Buret only
-03P2	2000 ml Bottle only, 29/42

-04	100 ml x 1/5 ml div. Complete with 4000 ml bottle, 29/42
-04P1	100 ml Buret only
-04P2	4000 ml Bottle only, 29/42

## 180210

BURET, AUTOMATIC. Similar to 180200, but with Teflon stopcock and reservoir bottle.

CODE	DESCRIPTION
-01	10 ml x 1/20 ml div. Complete with 1000 ml bottle, 24/40
-01P1	10 ml Buret only
-01P2	1000 ml Bottle only, 24/40
-02	25 ml x 1/10 ml div. Complete with 1000 ml bottle, 24/40
-02P1	25 ml Buret only
-02P2	1000 ml Bottle only, 24/40
-03	50 ml x 1/10 ml div. Complete with 2000 ml bottle, 29/42
-03P1	50 ml Buret only
-03P2	2000 ml Bottle only, 29/42
-04	100 ml x 1/5 ml div. Complete with 4000 ml bottle, 29/42
-04P1	100 ml Buret only
-04P2	4000 ml Bottle only, 29/42

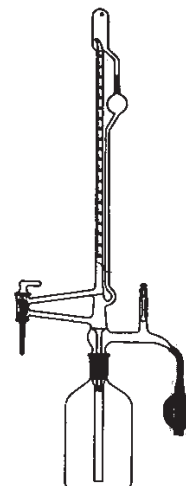

180210

## 180270

BURET, TETRA ETHYL LEAD. For use with high octane fuels. Sturdily constructed and highly accurate buret with smooth acting stopcock. Supplied complete with heavy walled connecting tube and replaceable delivery tip.

CODE	DESCRIPTION
-01	3 ml BURET COMPLETE
-01P1	3 ml Buret only
-01P2	Connecting tube only
-01P3	Delivery tip only
-02	4 ml BURET COMPLETE
-02P1	4 ml Buret only
-02P2	Connecting tube only
-02P3	Delivery tip only

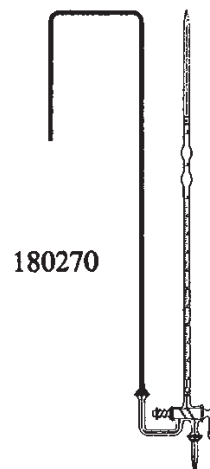

180270

## 180330

BURET, AIR TESTER. An accurately calibrated gas buret for use with brewery air testing apparatus. Fabricated from heavy glass for long lasting service and equipped with a Teflon stopcock and an integral caustic trap at the top. This buret is compatible with most of the air testing apparatus' in use in breweries throughout the world.

CODE	CAPACITY (ML)
-01	25
-02	50

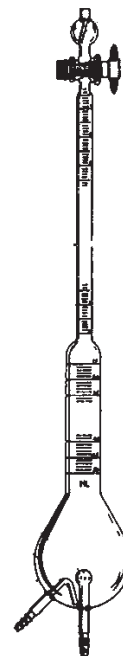

180330

### 180340

BURET, GAS, TUTWILER. With 10 ml upper reservoir and graduated lower chamber. Used for the determination of H<sub>2</sub>S in gases. The 100 ml size is referenced: UOP 9-59; American Gas Chemists Handbook (1929); and Tutwiler, C.C., J. Am. Chem. Soc. (1901)\*.



CODE	CAPACITY (ML)
------	---------------

-01	50
-02	100*
-03	500
-04	1000

### 180345

BURET, GAS, TUTWILER, TEFLON. Identical to 180340, except with Teflon stopcocks.

CODE	CAPACITY (ML)
------	---------------

-01	50
-02	100
-03	500
-04	1000

180340 180345

## 190040

COLUMN, ANALYTICAL ADSORPTION, ASTM D2002. For use in the test for isolation of representative saturates fraction from low-olefinic petroleum naphthas. Also specified for UOP Method 325. Consists of a column section approximately 870 mm long with bulb and  $\text{S } 14/35$  outer ground joint and a  $\text{S } 14/35$  inner top adapter. Both parts are equipped with hooks, and complete unit is supplied with springs.

CODE	DESCRIPTION
-00	COLUMN COMPLETE
-01	Column only
-02	Top adapter only
-03	Stainless steel springs, 1 pair

## 190050

COLUMN, ADSORPTION, Standard, ASTM D1319. For use in the test for hydrocarbon types in liquid petroleum products by fluorescent indicator adsorption. Top joint is  $\text{S } 28/12$ . Supplied complete with 1200 mm long analyzer section of 3 mm od tubing.

CODE	DESCRIPTION
-00	COMPLETE COLUMN with 1 pk (50/pk) analyzer section
-01	Column only (upper part)
-02	Analyzer section (50/pk)

## 190055

COLUMN, ADSORPTION, TRU-BORE, ASTM D1319. Similar to 190050, but made with true bore tubing in the attached analyzer section and with column tip attached by means of a  $\text{S } 12/2$  ground glass joint. Supplied complete with tip, but without  $\text{S } 12/2$  joint clamp.

CODE	DESCRIPTION
-00	COLUMN COMPLETE, with tip
-01	Column Only
-02	Tip Only

(FOR CLAMP USE 285100, SIZE #12)

## 190060

COLUMN, CHROMATOGRAPHIC, PLAIN. Universally suitable for many separations.

CODE	I.D.	LENGTH, CM	CAPACITY
-01	22 mm	25	Approx. 90 ml

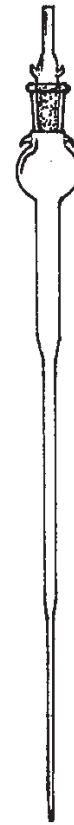

190040



190050



190055



190060



190070

### 190070

(SAME AS HGF#01890I)

COLUMN, DRYING. Meets EPA specifications, reservoir holds approximately 60 ml, column section is 19 mm I.D. x 10 cm.

CODE

-01

### 190100

COLUMN, CHROMATOGRAPHIC. Plain with 2 mm Teflon stopcock (Codes 10, 11, & 12 have 4 mm Teflon stopcocks).

CODE	I.D. (MM)	LENGTH (CM)
------	-----------	-------------

-01	10	30
-02	10	45
-03	19	30
-04	19	45
-05	22	50
-06	25	45
-07	25	60
-08	30	60
-09	30	90
-10	41	90
-11	49	90
-12	59	120

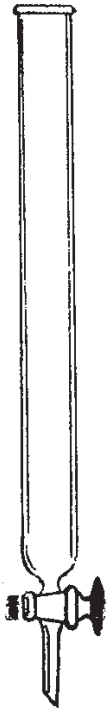

190100

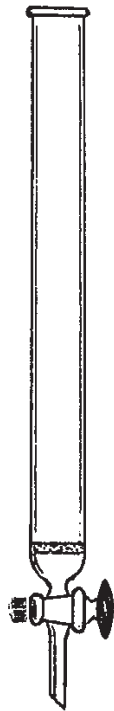

190110

### 190110

COLUMN, CHROMATOGRAPHIC. With coarse porosity fritted disc and 2 mm Teflon stopcock. (Codes 10, 11, & 12 have 4 mm Teflon stopcocks)

CODE	I.D. (MM)	LENGTH (CM)
------	-----------	-------------

-01	10	30
-02	10	45
-03	19	30
-04	19	45
-05	22	50
-06	25	45
-07	25	60
-08	30	60
-09	30	90
-10	41	90
-11	49	90
-12	59	120

## 190130

COLUMN, CHROMATOGRAPHIC. With coarse porosity fritted disc, 2mm Teflon stopcock and 24/40 outer joint at top.

CODE	I.D. (MM)	LENGTH (CM)
-01	10	30
-02	10	45
-03	19	45
-04	19	60
-05	25	60
-06	30	90

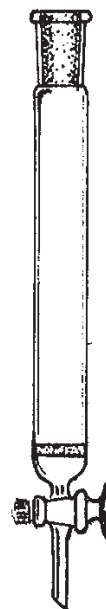

190130

## 190160

COLUMN, CHROMATOGRAPHIC. Plain with reservoir. Top is tooled for rubber stopper and lower tip is 2 mm capillary. Length of column is 30 cm unless other length is specified.

CODE	I.D. (MM)	RESERVOIR (ML)
-01	10	50
-02	10	100
-03	10	250
-04	10	500
-05	12	50
-06	12	100
-07	12	250
-08	12	500
-09	19	50
-10	19	100
-11	19	250
-12	19	500



190160

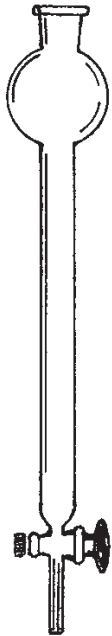

190170

## 190170

COLUMN, CHROMATOGRAPHIC. Plain with reservoir. Similar to 190160, but with 2 mm bore Teflon stopcock. Length of column is 30 cm unless other length is specified.

CODE	I.D. (MM)	RESERVOIR (ML)
-01	10	50
-02	10	100
-03	10	250
-04	10	500
-05	12	50
-06	12	100
-07	12	250
-08	12	500
-09	19	50
-10	19	100
-11	19	250
-12	19	500



190180

## 190180

COLUMN, CHROMATOGRAPHIC, GENERAL UTILITY. A "cleanup" column of simple design. Column section is 9 mm I.D. and 300 mm long with tip drawn to 1 mm I.D.

CODE	RESERVOIR (ML)
-01	50
-02	75
-03	100
-04	200

## 192002-A

CONCENTRATOR, EVAPORATIVE, KUDERNA-DANISH. Complete apparatus consists of a graduated lower sample tube, a special erlenmeyer-shaped flask section, and a 3-bulb "Snyder" column at top.

CODE	DESCRIPTION
-A	COMPLETE SET UP 3 PARTS WITH HOOKS AND SPRINGS
-AP1	Snyder Column
-AP2	KD Flask, 500 ml, with hooks
-AP3	Concentrator tube, 10 ml, with hooks
-AP4	Stainless steel springs, 1 pair

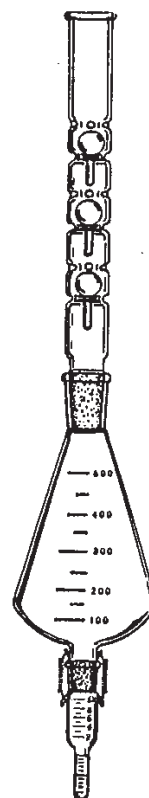

192002-A

## 192002-B

Same as 192002-A but with Keck clip joint connector.

CODE	DESCRIPTION
-B	COMPLETE SET UP 3 PARTS WITH KECK CLIP
-BP1	Snyder Column
-BP2	KD Flask, 500 ml, no hooks
-BP3	Concentrator tube, 10 ml, no hooks
-BP4	Keck clip #19

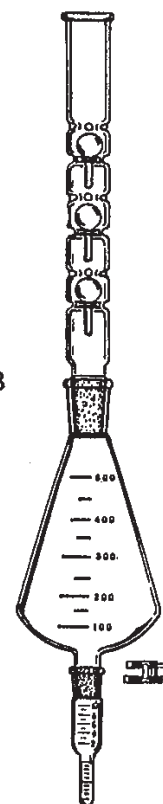

192002-B

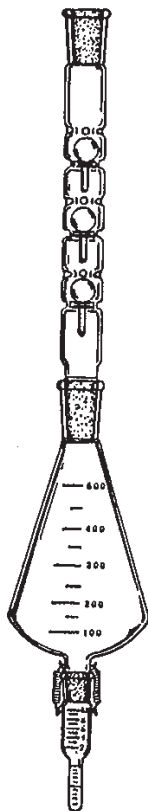

192002-C

## 192002-C

Same as 192002-A but with 24/40 top joint on the Snyder column.

CODE	DESCRIPTION
-C	COMPLETE SET UP 3 PARTS WITH HOOKS AND SPRINGS
-CP1	Snyder Column, 24/40 joints top and bottom
-CP2	KD Flask, 500 ml, with hooks
-CP3	Concentrator tube, 10 ml, with hooks
-CP4	Stainless steel springs, 1 pair

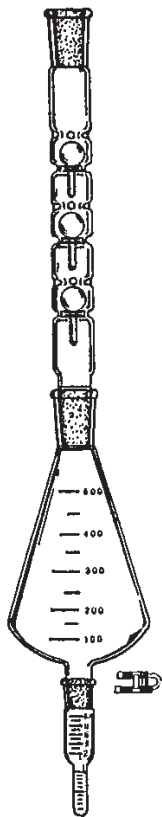

192002-D

## 192002-D

Same as 192002-B but with 24/40 top joint on the Snyder column and with Keck clip connector.

CODE	DESCRIPTION
-D	COMPLETE SET UP 3 PARTS WITH KECK CLIP
-DP1	Snyder Column, 24/40 joints top and bottom
-DP2	KD Flask, 500 ml, no hooks
-DP3	Concentrator tube, 10 ml, no hooks
-DP4	Keck clip #19

## 192002-M

MICRO SNYDER COLUMN,  $\text{\textcircled{F}}$  19/22.

CODE W/HOOKS	CODE W/O HOOKS	DESCRIPTION
-M1A	-M1B	One Bulb (97 mm O.A.L.)
-M2A	-M2B	Two Bulb (132 mm O.A.L.)
-M3A	-M3B	Three Bulb (167 mm O.A.L.)



192002-M

## 192005

FLASK, KUDERNA-DANISH, with  $\text{\textcircled{F}}$  24/40 top joint and  $\text{\textcircled{F}}$  19/22 lower joint. With hooks.

CODE	CAPACITY (ML)
-01	125
-02	250
-03	500
-04	1000

192005



## 192006

FLASK, KUDERNA-DANISH. Same as 192005 but without hooks.

CODE	CAPACITY (ML)
-01	125
-02	250
-03	500
-04	1000

192006



## 192010

CONCENTRATOR TUBE, lower graduated section on all sizes is 1 ml x 1/10 ml divisions.

CODE W/HOOKS	CODE W/O HOOKS	CAPACITY (ML)
-01	-11	5
-02	-12	10
-03	-13	15
-04	-14	25

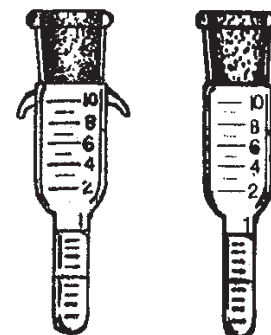

192010

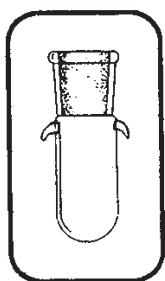

192011

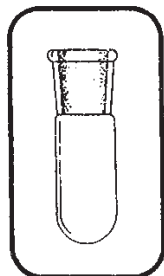

192012

### 192011

CONCENTRATOR TUBE UNGRADUATED. With hooks.

CODE	DESCRIPTION
------	-------------

-01	10 ml Test tubed bottom
-02	10 ml, 1 ml lower section

### 192012

CONCENTRATOR TUBE UNGRADUATED. No hooks.

CODE	DESCRIPTION
------	-------------

-01	10 ml Test tubed bottom
-02	10 ml, 1 ml lower section

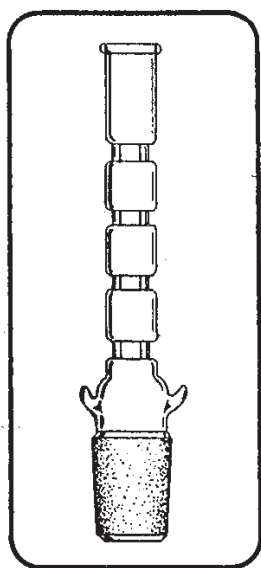

192040

### 192040

MICRO CONDENSER. Modified Micro-Snyder.

CODE	DESCRIPTION
------	-------------

-01	3 Chamber Column, with hooks
-02	3 Chamber Column, no hooks

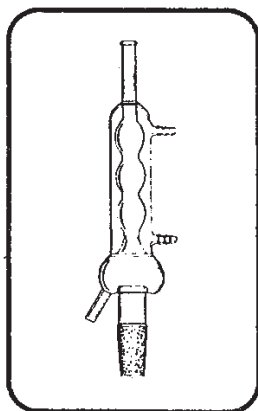

192050

### 192050

(Same as HGF#018694)

CONDENSER, SOLVENT RECOVERY. Designed to recover solvents escaping during evaporative concentrations. Allows work to be done outside of venthood.

CODE	DESCRIPTION
------	-------------

-01	24/40 joint, approximate height 265 mm
-----	--

## 200010

CONDENSER, Liebig, Plain.

CODE	JACKET LENGTH (MM)
------	--------------------

-01	200
-02	300
-03	400
-04	500



200010

## 200020

CONDENSER, Liebig. With  $\text{§}$  24/40 joint at the bottom.

CODE	JACKET LENGTH (MM)
------	--------------------

-01	200
-02	300
-03	400
-04	500



200020

## 200030

CONDENSER, Liebig. With  $\text{§}$  24/40 joint at top.

CODE	JACKET LENGTH (MM)
------	--------------------

-01	200
-02	300
-03	400
-04	500



200030

## 200040

CONDENSER, Liebig. With  $\text{§}$  24/40 joints at top and bottom.

CODE	JACKET LENGTH (MM)
------	--------------------

-01	200
-02	300
-03	400
-04	500



200040



200050

### 200050

CONDENSER, Graham, Plain.

CODE	JACKET LENGTH (MM)
------	--------------------

-01	200
-02	300
-03	400

### 200060

CONDENSER, Graham. With  $\text{K}$  24/40 joint at the bottom.

CODE	JACKET LENGTH (MM)
------	--------------------

-01	200
-02	300
-03	400



200060

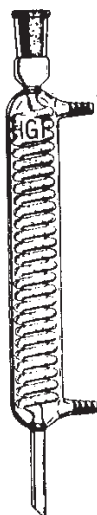

200070

### 200070

CONDENSER, Graham. With  $\text{K}$  24/40 joint at top.

CODE	JACKET LENGTH (MM)
------	--------------------

-01	200
-02	300
-03	400



200080

### 200080

CONDENSER, Graham. With  $\text{K}$  24/40 joints at top and bottom.

CODE	JACKET LENGTH (MM)
------	--------------------

-01	200
-02	300
-03	400

## 200090

CONDENSER, West Plain.

CODE      JACKET LENGTH (MM)

---

-01	200
-02	300
-03	400

## 200100

CONDENSER, West. With  $\frac{3}{4}$  24/40 joint at bottom.

CODE      JACKET LENGTH(MM)

---

-01	250
-02	300
-03	400
-04	500
-05	600

## 200110

CONDENSER, West. With  $\frac{3}{4}$  24/40 joint at top.

CODE      JACKET LENGTH (MM)

---

-01	250
-02	300
-03	400
-04	500
-05	600

## 200120

CONDENSER, West. With  $\frac{3}{4}$  24/40 joints at top and bottom.

CODE      JACKET LENGTH (MM)

---

-01	250
-02	300
-03	400
-04	500
-05	600



200090



200100



200110



200120



200140

## 200140

CONDENSER, Allihn, Plain.

CODE	JACKET LENGTH (MM)
------	--------------------

-01	200
-02	250
-03	300
-04	400
-05	500
-05	600



200150

## 200150

CONDENSER, Allihn. With  $\text{K}$  24/40 joint at bottom.

CODE	JACKET LENGTH (MM)
------	--------------------

-01	200
-02	250
-03	300
-04	400
-05	500
-06	600

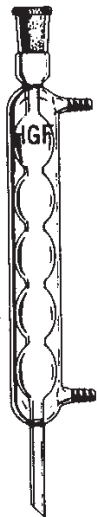

200160

## 200160

CONDENSER, Allihn. With  $\text{K}$  24/40 joint at top.

CODE	JACKET LENGTH (MM)
------	--------------------

-01	200
-02	250
-03	300
-04	400
-05	500
-06	600



200170

## 200170

CONDENSER, Liebig. With  $\text{K}$  24/40 joints at top and bottom.

CODE	JACKET LENGTH (MM)
------	--------------------

-01	200
-02	250
-03	300
-04	400
-05	500
-06	600

## 200190

CONDENSER, Liebig. With  $\nabla$  24/40 joints at top and bottom. Jacket extends to enclose both top and bottom joints. Jacket length is measured from top of lower joint to top of upper joint.

CODE	JACKET LENGTH (MM)
------	--------------------

-01	300
-02	350
-03	400
-04	500

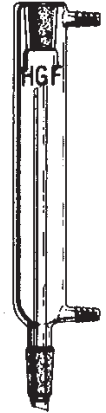

200190

## 200220

CONDENSER, Allihn. With  $\nabla$  24/40 joints at top and bottom. Jacket encloses both top and bottom joints. Jacket length is measured from top of bottom joint to top of upper joint.

CODE	JACKET LENGTH (MM)
------	--------------------

-01	300
-02	350
-03	400
-04	500

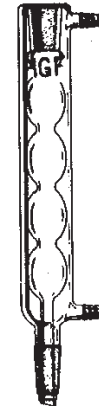

200220

## 200230

CONDENSER, Graham. With  $\nabla$  24/40 joint at top. Jacket encloses joint.

CODE	JACKET LENGTH (MM)
------	--------------------

-01	300
-02	350

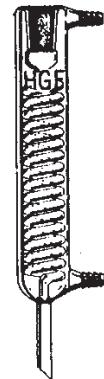

200230

## 200240

CONDENSER, Graham. With 24/40 joints at top and bottom. Jacket encloses top joint.

CODE	JACKET LENGTH (MM)
------	--------------------

-01	250
-02	350

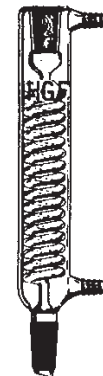

200240

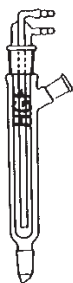

200250

## 200250

CONDENSER, HOPKINS. Consists of a separable cold-finger and body connected by a  $\text{K} 45/50$  ground joint, an inner drip-tip joint for connection to apparatus and a  $75^\circ$  side outer joint for venting.

CODE	COLD FINGER LENGTH (MM)	BTM & SIDE JT. (K)
-01	200	24/40
-02	250	24/40
-03	300	24/40

## 200300

CONDENSER, REFLUX. A simple condenser for insertion into various apparatus'.

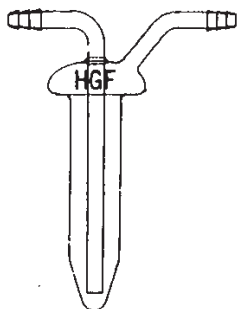

200300

CODE	DIAM. OF BULB (MM)	DIAM. OF COLD FINGER (MM)	LENGTH OF COLD FINGER (MM)
-01	25	10	75
-02	25	10	100
-03	25	10	150
-04	35	15	75
-05	35	15	100
-06	35	15	150
-07	45	32	150
-08	45	32	200
-09	55	41	225
-10	55	41	300
-11	60	45	110
-12	60	45	200

## 200310

CONDENSER, DRY ICE. Consisting of Dewar-type dry ice chamber with large hose connection and an inner  $\text{\textcircled{24/40}}$  joint at bottom for connection to apparatus.

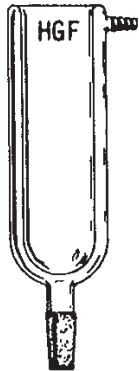

200310

CODE	APPROX. CAP'Y (ML)	I.D. (MM)	DEPTH (MM)
-01	100	32	150
-02	200	42	180
-03	300	51	180
-04	400	54	200
-05	500	54	250
-06	600	61	250
-07	700	61	270
-08	800	67	270
-09	900	67	300
-10	1000	72	300

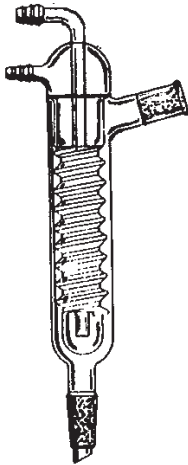

200320

## 200320

CONDENSER, FRIEDRICH. Inner molded tube provides long vapor path, good transfer and anti-flooding characteristics.

CODE	APPROX. OVERALL LENGTH (MM)	$\text{\textcircled{24/40}}$ JOINTS
-01	325	24/40
-02	330	29/42

## 210200

DISTILLING APPARATUS, "Iowa State". Used for determinations in the citrus industry, but applicable to other distilling procedures.

CODE	DESCRIPTION
------	-------------

-00	COMPLETE
-01	Iowa State Adapter, with inclined plate
-02	Condenser, 200 mm, $\text{S } 28/15$ socket joint
-03	Flask, 500 ml, $\text{F } 24/40$ outer joint

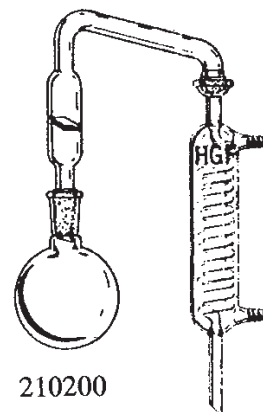

210200

## 210300

DISTILLING APPARATUS, Cyanide. (ASTM D2036). Flask is 1000 ml and all joints are  $\text{F } 19/38$  except the large joint on the condenser, which is  $\text{F } 45/50$ .

CODE	DESCRIPTION
------	-------------

-00	COMPLETE
-01	Flask, 2 neck
-02A	Condenser Jacket (Outer)
-02B	Cold Finger Condenser (Inner)
-03	Inlet tube for flask
-04	Absorber, w/fritted dispersion tube and $75^\circ$ angle connector
-05	Absorber tube

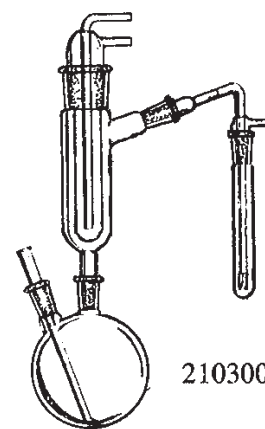

210300

## 210301

DISTILLING APPARATUS, Cyanide (125 ml).

CODE	DESCRIPTION
------	-------------

-00	COMPLETE
-01	Inlet Tube for flask
-02	125 ml Flask
-03	Condenser Jacket (Outer)
-04	Cold Finger Condenser (Inner)
-05	Absorber, w/fritted dispersion tube
-06	Absorber Tube

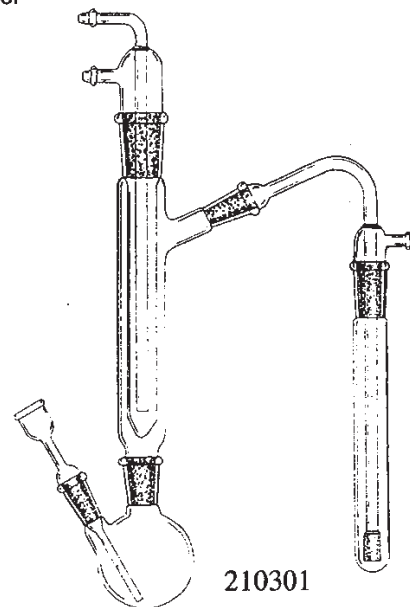

210301

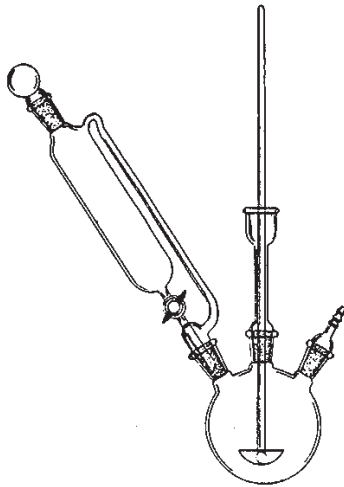

210304

## 210304

DISTILLATION APPARATUS, Hydrogen Sulfide Determination § 24/40 to determine the amounts of H<sub>2</sub>S released from wastes. (EPA test method)

CODE	DESCRIPTION
-00	COMPLETE
-01	Stopper, 24/40
-02	Addition Funnel, 125 ml
-03	Flask, 500 ml, 3 neck
-04	Stir Rod
-05	Stir Bearing
-06	Stir Blade, Teflon
-07	Connecting Adapter

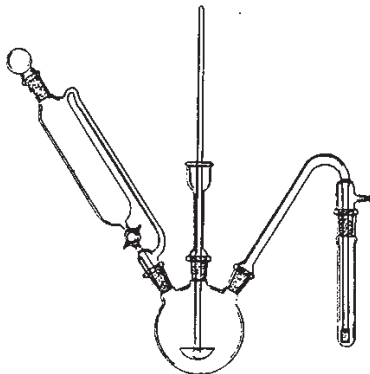

210305

## 210305

DISTILLATION APPARATUS, Hydrogen Cyanide Determination § 24/40. Same as 210304 but with absorber (Scrubber). (EPA Test Method)

CODE	DESCRIPTION
-00	COMPLETE
-01	Stopper, 24/40
-02	Addition Funnel (125 ml)
-03	Flask, 500 ml, 3 neck
-04	Stir Rod
-05	Stir Bearing
-06	Stir Blade, Teflon
-07	Fritted Absorber "C"
-08	Absorber Test Tube

## 210310

DISTILLING APPARATUS, Micro Kjeldahl. With vacuum jacket.

CODE	DESCRIPTION
------	-------------

-00	COMPLETE
-----	----------

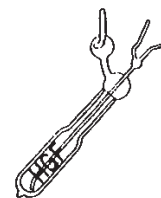

210310

## 210320

DISTILLING APPARATUS, Micro Kjeldahl. Steam generating flask is 500 ml and sample flask is 50 ml. Condenser has a 300 mm jacket.

CODE	DESCRIPTION
------	-------------

-00	COMPLETE
-----	----------

-01	Steam Generator
-02	Thistle tube for steam generator
-03	Steam delivery adapter, w/acid funnel
-04	Sample digestion flask, 50 ml
-05	Condenser

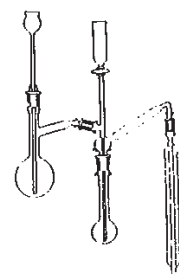

210320

## 210330

DISTILLING APPARATUS, Micro. All joints are  $\nabla$  14/20 and have hooks for springs. Thermometer is not included.

CODE	DESCRIPTION
------	-------------

-00	COMPLETE
-----	----------

-01	Therm-adapter
-02	Distilling head and Vigreux column assembly
-03	Boiling flask, 50 ml, pear-shaped
-04	Condenser
-05	Vacuum adapter, with four $\nabla$ 2 mm stopcocks and approx. 10 ml receiving chamber
-06	Receiving flask, 25 ml, round bottom
-07	Spring, stainless steel
-08	Stopper, $\nabla$ 14/20

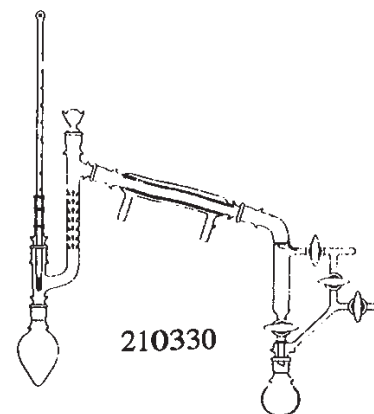

210330

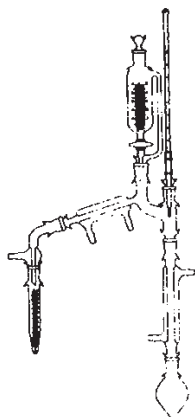

210340

## 210340

DISTILLING APPARATUS, Micro. All joints are  $\text{\textcircled{K}}$  14/20 and have hooks for springs. Thermometer is not included.

CODE	DESCRIPTION
------	-------------

-00	COMPLETE
-01	Therm-adapter
-02	Claisen head and Condenser assembly
-03	Jacketed distilling column (condenser)
-04	Boiling flask, 50 ml, pear-shaped
-05	Funnel, addition-type, 50 ml, graduated
-06	Stopper, $\text{\textcircled{K}}$ 14/20
-07	Receiving adapter 105°, w/vacuum take-off
-08	Receiving tube, graduated, 12 ml
-09	Spring, stainless steel

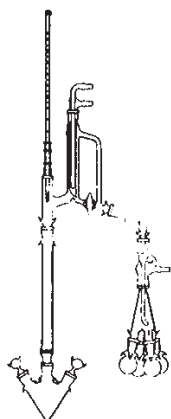

210350

## 210350

DISTILLING APPARATUS, Micro. All joints are  $\text{\textcircled{K}}$  14/20 and have hooks for springs. Thermometer is not included.

CODE	DESCRIPTION
------	-------------

-00	COMPLETE
-01	Therm-adapter
-02	Distilling head, w/cold finger condenser
-03	Distilling column
-04	Boiling flask, 3-neck, pear-shaped
-05	Adapter, curved, 105°
-06	Vacuum adapter only for receiver "cow"
-07	Multiple receiver ("cow")
-08	Receiving flask, 15 ml, round bottom
-09	Stopper, $\text{\textcircled{K}}$ 14/20
-10	Spring, stainless steel

## 210360

DISTILLATION APPARATUS, Petroleum. (ASTM D1160). For distillation of petroleum products at reduced pressure.

CODE	DESCRIPTION
-00	COMPLETE (As illustrated)
-01	Boiling Flask, long neck, w/thermowell
-02	Distilling column
-03	Condensing assembly
-04	Receiver, graduated & jacketed, 200 ml
	ACCESSORIES (Not illustrated)
-05	Silvered & vacuum jacketed column condenser assembly
-06	Boiling flask, short neck, w/thermowell
-07	Receiver, graduated & jacketed, 1000 ml

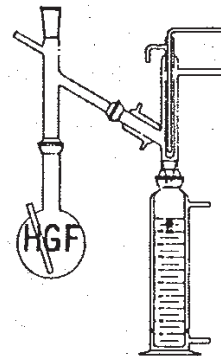

210360

## 210370

DISTILLING APPARATUS, Water. With constant level device. For continuous production of distilled water at a rate of approximately one liter per hour.

CODE	DESCRIPTION
-00	COMPLETE
-01	Boiling flask, 2000 ml, w/level device
-02	Condenser, 300 mm jacket

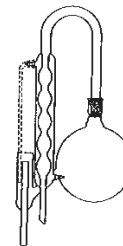

210370

## 210380

DISTILLING APPARATUS, Water, Yoe-Type. With S 35/20 joint connection on side arm,  $\text{K}$  29/42 stopper on flask neck and  $\text{K}$  24/40 joint on condenser.

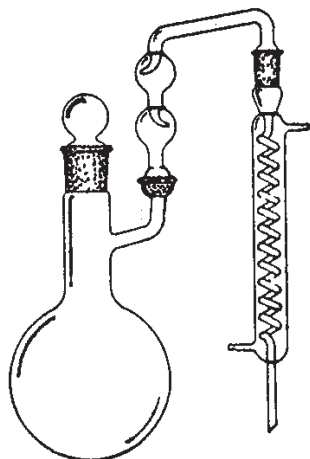

210380

CODE	DESCRIPTION	FLASK CAP'Y (ML)	CONDENSER LGTH. (MM)
-01	COMPLETE	1000	300
-01P1	Boiling Flask		
-01P2	Condenser		
-01P3	Stopper, $\text{K}$ 29/42		
-01P4	Connecting adapter, w/traps		
-02	COMPLETE	3000	400
-02P1	Boiling Flask		
-02P2	Condenser		
-02P3	Stopper, $\text{K}$ 29/42		
-02P4	Connecting adapter, w/traps		
-03	COMPLETE	5000	500
-03P1	Boiling Flask		
-03P2	Condenser		
-03P3	Stopper, $\text{K}$ 29/42		
-03P4	Connecting adapter, w/traps		

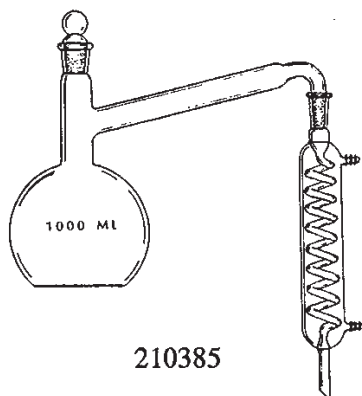

210385

## 210385

DISTILLATION APPARATUS.

CODE	DESCRIPTION
-00	COMPLETE
-01	Stopper, #27
-02	Phenol Flask, 1000 ml
-03	Graham Condenser, 200 mm

## 210390

DISTILLING APPARATUS, Reduced pressure. Boiling flask is 1000 ml; claisen head has two  $\text{K} 10/30$  outer joints for 75 mm thermometer immersion; condenser has 500 mm water jacket; vacuum-type distilling receiver has four  $\text{K} 4$  mm stopcocks and is graduated to 50 ml x 1/10 ml divisions. Receiving cylinder is graduated to 250 ml x 2 ml divisions. All joints (except thermometer joints) are  $\text{K} 24/40$ .

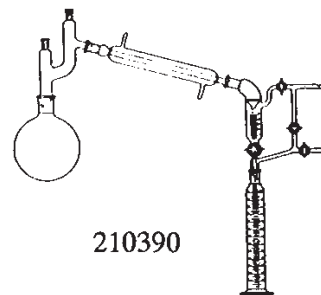

210390

CODE	DESCRIPTION
------	-------------

-00	COMPLETE
-01	Boiling Flask, 1000 ml, $\text{K} 24/40$
-02	Claisen head, $\text{K} 24/40$ and $10/30$
-03	Condenser, 500 mm jacket, $\text{K} 24/40$
-04	Distilling receiver, graduated, 50 ml
-05	Receiving Cylinder, graduated, 250 ml

## 211510

DISTILLING COLUMN, Plain. With indentations to support packing material. Column is 19 mm I.D. with  $24/40$  joints.

CODE	LENGTH (MM)
------	-------------

-01	300
-02	450
-03	600
-04	900



211510

## 211520

DISTILLING COLUMN, Plain. With perforated cone support for packing material. Column is 19 mm I.D. with  $24/40$  joints.

CODE	LENGTH (MM)
------	-------------

-01	300
-02	450
-03	600
-04	900



211520



211530

### 211530

DISTILLING COLUMN, Vigreux. With indentations over entire length for improved vapor/liquid contact. Column is 19 mm I.D. with 24/40 joints.

CODE	LENGTH (MM)
------	-------------

-01	200
-02	300
-03	450
-04	600
-05	900

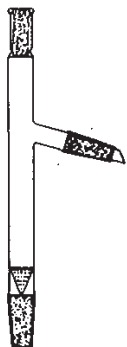

211550

### 211550

DISTILLING COLUMN, Plain. With perforated cone support and a 24/40 side joint set at 105°. Top of column has  $\text{F}$  10/30 outer joint arranged for 75 mm thermometer immersion. Column is 19 mm I.D. with 24/40 lower joint.

CODE	LENGTH (MM)
------	-------------

-01	150
-02	250
-03	350

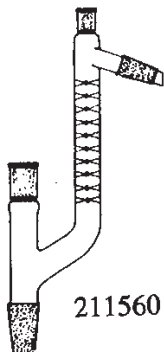

211560

### 211560

DISTILLING COLUMN, Vigreux. With indentions over column length, sealed-on Claissen head and upper side joint set at 105°. Outer joint at top of column is  $\text{F}$  10/30 for 75 mm thermometer immersion. Column is 19 mm I.D. with 24/40 joints.

CODE	LENGTH (MM)
------	-------------

-01	100
-02	150
-03	200
-04	250
-05	300

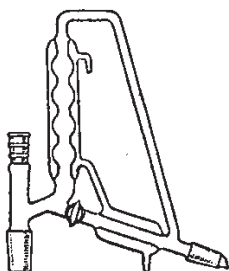

211570

### 211570

DISTILLING HEAD, Variable reflux. With adjustable flow stopcock and  $\text{F}$  10/30 outer joint at top for 75 mm thermometer immersion.

CODE
------

-01
-----

## 211580

DISTILLING HEAD, Variable reflux. With arrangement of stopcocks to permit removal of receiver without interruption of distillation. Top joint is a 10/30 outer for 75 mm thermometer immersion, lower joints are 24/40.

### CODE

-01

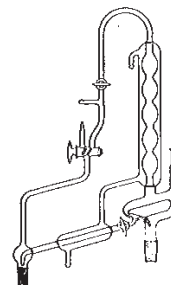

211580

## 211600

DISTILLING RECEIVER, ADA. A receiver which is compatible with automatic distillation apparatus'. All critical dimensions - Precision bore borosilicate glass, standard I.D., standard overall height, calibration marks, are identical with those required for the accurate operation of ADA machines.

### CODE DESCRIPTION

-01 Standard Wall  
-02 Medium Wall



211600

211605

## 211605

DISTILLING RECEIVER, "HERZOG TYPE". Similar to 211600 but manufactured to fit Herzog Type distillation machines.

### CODE

-01

## 211610

DISTILLING RECEIVER, Vacuum. Revolving-type multiple distilling receiver arranged to progressively fill four 50 ml receiving flasks. With vertical top outer joint and with a stopcock on the vacuum connection. All joints are  $\text{\textcircled{K}}$  24/40.

### CODE DESCRIPTION

-00 COMPLETE  
-01 Top Adapter, w/stopcock  
-02 Distribution flask ("cow")  
-03 Receiving flask, 50 ml (4 req'd)

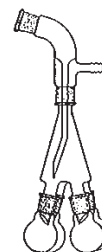

211610

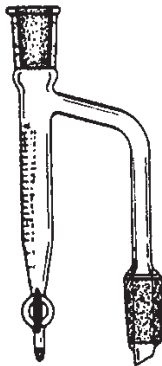

211620  
211625

## 211620

DISTILLING RECEIVER, Moisture Test, Barrett-type. For the determination of water in petroleum or bituminous products, and other uses. Equipped with 3/2 mm Glass stopcock. Please specify if other joint sizes or capacities are desired.

CODE	CAPACITY (ML)	DIV. (ML)	JOINT SIZE
-01	5	2/10	24/40
-02	10	2/10	24/40
-03	20	2/10	24/40
-04	25	2/10	24/40

## 211625

DISTILLING RECEIVER, same as 211620 except with a Teflon stopcock. Please specify if other joint sizes or capacities are desired.

CODE	CAPACITY (ML)	DIV. (ML)	JOINT SIZE
-01	5	2/10	24/40
-02	10	2/10	24/40
-03	20	2/10	24/40
-04	25	2/10	24/40

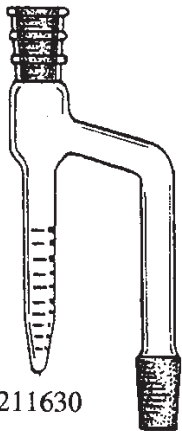

211630

## 211630

DISTILLING RECEIVER, Moisture Test, Dean-Stark. ASTM D95 & E123. Please specify if other joint sizes or capacities are desired.

CODE	CAPACITY (ML)	DIV. (ML)	JOINT SIZE
-01	10	1/10 & 2/10	24/40
-02	25	1/10 & 2/10	24/40

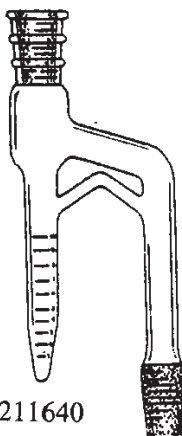

211640

## 211640

DISTILLING RECEIVER, Dean-Stark. Similar to 211630 but with solvent return tube. Please specify if other joint sizes or capacities are desired.

CODE	CAPACITY (ML)	DIV. (ML)	JOINT SIZE
-01	5	1/10	24/40
-02	10	1/10 & 2/10	24/40
-03	20	1/10 & 2/10	24/40
-04	25	1/10 & 2/10	24/40

## 211650

DISTILLING RECEIVER, Vacuum-type. Water jacketed and graduated receiver section.

CODE	CAPACITY (ML)	JOINT SIZE
-01	50	35/25
-02	50	24/40
-03	50	29/42
-04	100	35/25
-05	100	24/40
-06	100	29/42
-07	250	35/25
-08	250	24/40
-09	250	29/42

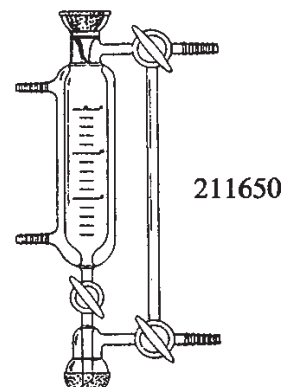

## 211680

DISTILLING RECEIVER, Micro. Similar to 211650, except with a capacity of 10 ml, divisions each 2/10 ml.

CODE	JOINT SIZE
-01	18/9
-02	14/20
-03	19/22
-04	24/40

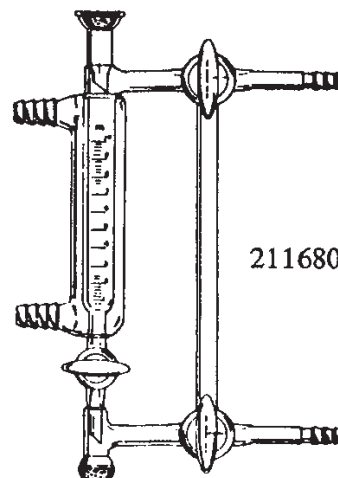

## 211690

DISTILLING RECEIVER, Cylindrical. Water jacketed and graduated.

CODE	CAPACITY (ML)	JOINT SIZE
-01	50	18/9
-02	50	19/22
-03	50	24/20
-04	100	18/9
-05	100	35/25
-06	100	24/40
-07	100	29/42
-08	250	35/25
-09	250	24/40
-10	250	29/42

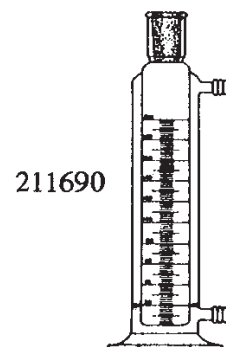

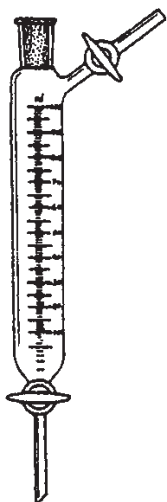

211700

## 211700

DISTILLING RECEIVER, Straight-type. Graduated from lower stopcock, and with stopcock at top for vacuum control.

CODE	CAPACITY (ML)	JOINT SIZE
-01	50	18/9
-02	50	19/22
-03	50	24/40
-04	100	18/9
-05	100	35/25
-06	100	24/40
-07	100	29/42
-08	250	35/25
-09	250	24/40
-10	250	29/42

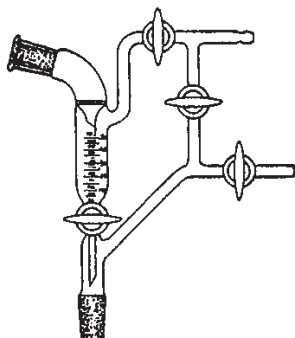

211710

## 211710

DISTILLING RECEIVER, Vacuum. Graduated from lower stopcock and with a stopcock arrangement to permit removal of product without interruption of vacuum distillation. Top joint is bent at 105° for connection to condenser.

CODE	CAPACITY (ML)	JOINT SIZE
-01	50	35/25
-02	50	24/40
-03	50	29/42
-04	100	35/25
-05	100	24/40
-06	100	29/42
-07	250	35/25
-08	250	24/40
-09	250	29/42

## OLDERSHAW BUBBLE PLATE COLUMNS

The Oldershaw columns described in this catalog vary in size from 19 mm to 75 mm. Their scope of operation varies from laboratory studies to pilot plant operation. These all glass perforated plate columns have a high efficiency which can be easily measured and correlates well with plate efficiencies in industrial towers. Further, as has been reported, the columns simulate full commercial operation for a variety of distillation techniques.

Speed in reaching equilibrium, high reflux rate, low operating holdup and uniformity of operation are some of the many advantages of the Oldershaw column.

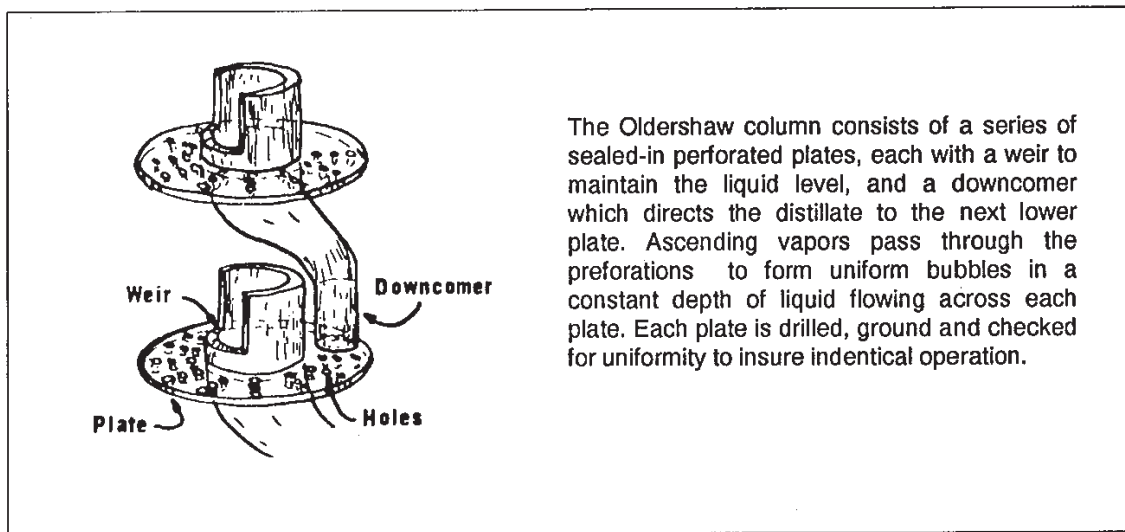

The Oldershaw column consists of a series of sealed-in perforated plates, each with a weir to maintain the liquid level, and a downcomer which directs the distillate to the next lower plate. Ascending vapors pass through the perforations to form uniform bubbles in a constant depth of liquid flowing across each plate. Each plate is drilled, ground and checked for uniformity to insure identical operation.

### OPERATING DATA

Column Diameter	28 mm	50 mm	75 mm
Max. Throughput, Iso-octane, Litres 1/hr.	5	18	48
Percent plate Eff. at total reflux.	66	65	61
Operating holdup per plate, ml	1.5	6	18
Pressure drop per plate, mm Hg.	1.0	1.0	1.2
Minimum Eff. operating pressure, mm Hg.	250	250	250

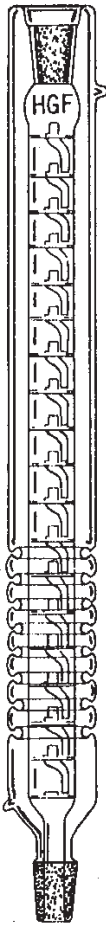

220405

## 220405

OLDERSHAW, BUBBLE PLATE COLUMN. Standard Taper ground joints. The column and joints are completely vacuum-jacketed and silvered for minimum heat loss. Sufficient bellows are used for expansion of the glass.

CODE	No. of Plate Sections	I. D. (MM)	JOINT (S)
-01	5	19	29/42
-02	5	28	29/42
-03	5	50	50/50
-04	10	19	29/42
-05	10	28	29/42
-06	10	50	50/50
-07	15	19	29/42
-08	15	28	29/42
-09	15	50	50/50
-10	20	19	29/42
-11	20	28	29/42
-12	20	50	50/50
-13	30	19	29/42
-14	30	28	29/42
-15	30	50	50/50
-16	40	19	29/42
-17	40	28	29/42
-18	40	50	50/50



220410

## 220410

OLDERSHAW, BUBBLE PLATE COLUMN. Plain, unjacketed column with S ground joints.

CODE	No. of Plate Sections	I. D. (MM)	JOINT (S)
-01	5	19	29/42
-02	5	28	29/42
-03	5	50	50/50
-04	10	19	29/42
-05	10	28	29/42
-06	10	50	50/50
-07	15	19	29/42
-08	15	28	29/42
-09	15	50	50/50
-10	20	19	29/42
-11	20	28	29/42
-12	20	50	50/50
-13	30	19	29/42
-14	30	28	29/42
-15	30	50	50/50
-16	40	19	29/42
-17	40	28	29/42
-18	40	50	50/50

## 220415

COLUMN, FOR RANDOM PACKING. Column is made with inverted cone packing support, and is silvered and evacuated to keep heat losses at a minimum. Sufficient bellows are provided for expansion of the glass. Supplied with  $\bar{3}$  ground joints. Column length is measured from top of packing support to bottom of upper ground joint.

CODE	Column Lgth. (MM)	I.D. (MM)	JOINT SIZE
-01	300	12	24/40
-02	300	19	29/42
-03	300	25	29/42
-04	300	30	34/45
-05	300	37	45/50
-06	300	50	50/50
-07	450	12	24/40
-08	450	19	29/42
-09	450	25	29/42
-10	450	30	34/45
-11	450	37	45/50
-12	450	50	50/50
-13	600	12	24/40
-14	600	19	29/42
-15	600	25	29/42
-16	600	30	34/45
-17	600	37	45/50
-18	600	50	50/50
-19	900	12	24/40
-20	900	19	29/42
-21	900	25	29/42
-22	900	30	34/45
-23	900	37	45/50
-24	900	50	50/50
-25	1200	12	24/40
-26	1200	19	29/42
-27	1200	25	29/42
-28	1200	30	34/45
-29	1200	37	45/50
-30	1200	50	50/50
-31	1350	12	24/40
-32	1350	19	29/42
-33	1350	25	29/42
-34	1350	30	34/45
-35	1350	37	45/50
-36	1350	50	50/50



220415

## 220420

DISTILLATE RECEIVER. For use with 19 mm and 28 mm Oldershaw or packing-type columns. The receiver consists of a graduated cylinder in a condenser. The condenser prevents loss of volatile products. All joints are  $\text{\textcircled{S}}$  18/9.

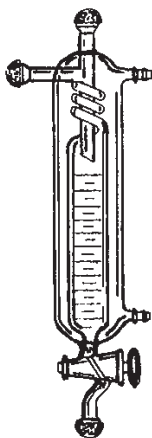

220420

220425

CODE	CAPACITY (ML)
------	---------------

-01	10
-02	25
-03	50
-04	100
-05	250
-06	500
-07	1000

## 220425

DISTILLATE RECEIVER. For use with 50 mm and 75 mm Oldershaw or packing-type columns. Same as 220420, but with  $\text{\textcircled{S}}$  28/15 ball joint at top. Other joints are  $\text{\textcircled{S}}$  18/9.

CODE	CAPACITY (ML)
------	---------------

-01	10
-02	25
-03	50
-04	100
-05	250
-06	500
-07	1000

## 220430

DISTILLATE RECEIVER. For use with 19 mm and 28 mm Oldershaw or packing-type columns. Similar to 220420, but is vacuum jacketed to prevent frosting when used with low temperature coolant. All joints are  $\text{\textcircled{S}}$  18/9.

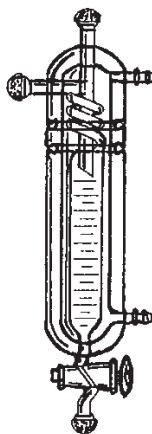

220430

CODE	CAPACITY (ML)
------	---------------

-01	10
-02	25
-03	50
-04	100
-05	250
-06	500
-07	1000

## 220435

DISTILLATE RECEIVER. For use with 50 mm and 75 mm Oldershaw or packing-type columns. Same as 220430, but with  $\text{\$}$  28/15 ball joint at top. Other joints are  $\text{\$}$  18/9.

CODE      CAPACITY (ML)

-01	10
-02	25
-03	50
-04	100
-05	250
-06	500
-07	1000

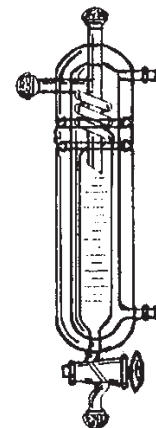

220435

## 220440

AUTOMATIC DISTILLATION HEAD, LIQUID DIVIDING. For use with 19 mm and 28 mm Oldershaw or packing-type columns. Vacuum jacketed and silvered to minimize heat losses. The jacket is equipped with bellows to allow for expansion due to temperature differential. Take-off control is by means of a swinging funnel with a glass enclosed iron core, energized by an external solenoid. In normal position the funnel returns the condensate through a drain tube to the column; in the energized position the condensate is directed to the take-off tube. The thermometer arm is designed for  $\text{\$}$  10/30, 3" immersion thermometer and the take-off tube terminates in  $\text{\$}$  18/9 ball joint. (Requires a 220480 or 220485 Condenser, a 220530 solenoid and a Thermometer).

CODE	TOP JOINT ( $\text{\$}$ )	BOTTOM JOINT ( $\text{\$}$ )
-01	29/42	24/40
-02	29/42	29/42
-03	29/42	34/45
-04	29/42	45/50

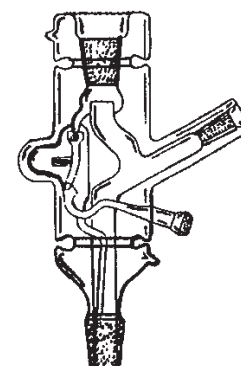

220440

220445

## 220445

AUTOMATIC DISTILLATION HEAD, LIQUID DIVIDING. For use with 50 mm Oldershaw and packing-type columns. Similar to 220440, but has larger capacity and  $\text{\$}$  28/15 take-off. (Requires a 220490 or 220495 Condenser, a 220530 Solenoid and a Thermometer).

CODE	TOP JOINT ( $\text{\$}$ )	BOTTOM JOINT ( $\text{\$}$ )
-01	50/50	50/50

220480

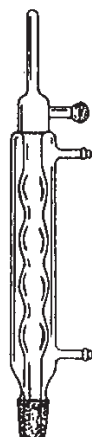

### 220480

REFLUX CONDENSER. For use with 220440 and 220465 Automatic Distillation Heads. Upper ball joint is  $\$ 18/9$  and lower inner joint is  $\$ 29/42$ .

CODE

---

-01

220485

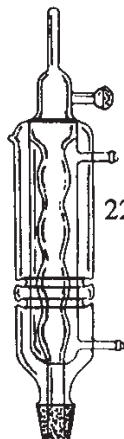

### 220485

REFLUX CONDENSER, VACUUM JACKETED. For use with 220440 and 220465 Automatic Distillation Heads. Similar to 220480 but vacuum jacketed to prevent frosting when used with low temperature coolants. Upper ball joint is  $\$ 18/9$  and lower inner joint is  $\$ 29/42$ .

CODE

---

-01

220490

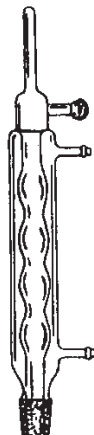

### 220490

REFLUX CONDENSER. For use with 220445 and 220470 Automatic Distillation Heads. Upper ball joint is  $\$ 28/15$  and lower inner joint is  $\$ 50/50$ .

CODE

---

-01

220495

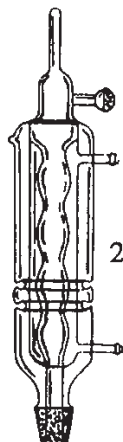

### 220495

REFLUX CONDENSER, VACUUM JACKETED. For use with 220445 and 220470 Automatic Distillation Heads. Similar to 220490 but vacuum jacketed to prevent frosting when using low temperature coolants. Upper ball joint is  $\$ 28/15$  and lower inner joint is  $\$ 50/50$ .

CODE

---

-01

## 220530

SOLENOID. For use with Automatic Liquid Dividing Heads. This solenoid is designed for operation on 110-120V A.C., **intermittent duty only**. Continuous application of power will overheat the unit and cause it to "burn out". The solenoid should be used with a ratio timer. Cycles should be no greater than one on to four off. **Example: 3 seconds on  
12 seconds off**

CODE

---

-01

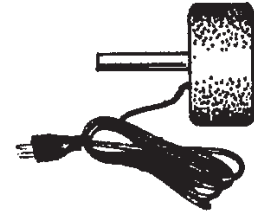

220530

## 220540

FLEXOPULSE TIMER. For use with 220530 Solenoid and Automatic Dividing Heads. A superior timing mechanism with independent on and off cycles. Maximum on and off time 120 seconds with minimum time settings of 0.5 seconds. 110-120VAC, 60Hz operation.

CODE

---

-01

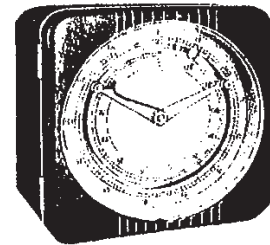

220540

## 220545

FEED SECTION. For use with 19 mm, 28 mm and 50 mm Oldershaw or packing-type columns. This unit can be placed between two sections of distillation column to provide a "continuous" or "center feed" column. This type column is used for the continuous separation of feed into high and low fractions. Vacuum jacketed and silvered to minimize heat loss. A 1/4" window allows observation of the internal dripper. A thermocouple well is provided for determining the temperature of the feed. The angled thermometer arm is designed for  $\text{K} 10/30$ , 3" immersion thermometer. (Requires a thermometer).

CODE	TOP & BOTTOM JOINTS	FEED TUBE INLET BALL JOINT
-01	29/42	18/9
-02	34/45	18/9
-03	45/50	28/15
-04	50/50	28/15

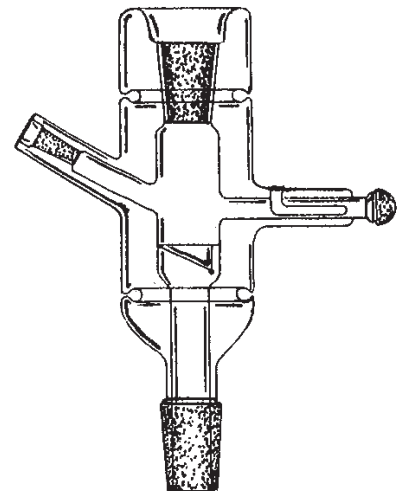

220545

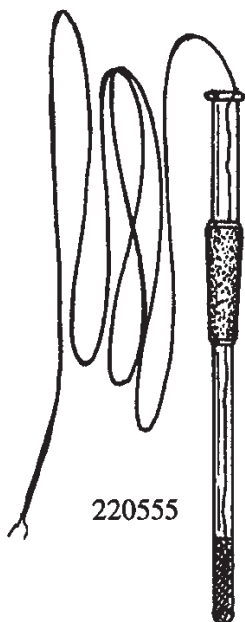

## 220555

THERMOCOUPLE ADAPTER. For use with Automatic Dividing Heads and Feed sections. Used in place of thermometer to provide a remote temperature reading. Iron/constantan thermocouple in glass adapter, no metal-vapor contact. 8 foot length. Equipped with  $\frac{10}{30}$  inner joint with 3" immersion length.

CODE

---

-01

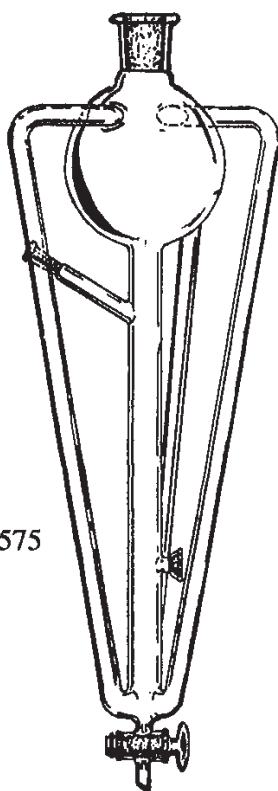

## 220575

REBOILER, THREE-LEG. For use with Oldershaw or packing-type columns. With spherical reservoir and three tangentially sealed legs, socket joint feed-in, and largebore stopcock at bottom. The thermometer arm is designed for  $\frac{10}{30}$ , 3" immersion thermometer. (Requires a thermometer).

CODE	No. of Legs	Reservoir (ML)	Top Jt. ( $\frac{\$}{\$}$ )	Feed Jt ( $\frac{\$}{\$}$ )
-01	3	500	29/42	18/9
-02	3	1000	50/50	28/15
-03	3	2000	50/50	28/15

## 230100

**DISTILLATION APPARATUS, SOLVENT.** For the distillation and recovery of solvents. Solvent is boiled and vapors pass upward through large-diameter sidearm of condenser/receiver where they condense and fall into cooled, graduated receiver section. As pure solvent is needed it may be drained from receiver through the connecting adapter and into any  $\frac{3}{4}$  24/40 jointed vessel. A dewar-type condenser is also provided for knockback of highly volatile solvent vapors. Provision for a thermometer is by  $\frac{3}{4}$  14/20 outer joint at top of sidearm. The connecting adapter is joined to the condenser/receiver by  $\frac{3}{8}$  12/5 spherical joint. All other joints are  $\frac{3}{4}$  24/40 and all stopcocks are teflon. The receiver section is graduated to 500 ml.

CODE	DESCRIPTION
-00	COMPLETE
-01	Condenser/Receiver
-02	Connecting adapter
-03	Dewar condenser
-04	#12 Clamp (Not pictured)

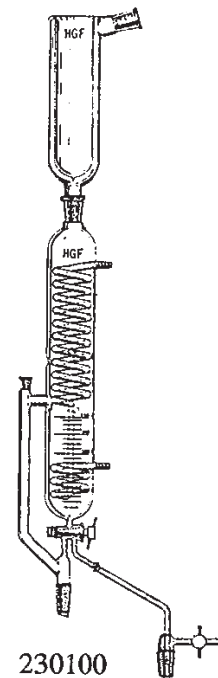

## 230150

**AUTOMATIC SOLVENT/FREON REPURIFICATION DISTILLING UNIT.**

CODE	DESCRIPTION
-00	COMPLETE
-01	Heating Mantle & Controller, 5000 ml
-02	Boiling Flask, 2 neck with stopper, 5000 ml
-03	Vigreux Column
-04	Automatic Liquid Dividing Head
-05	Thermometer, 3" immersion 0-150°C
-06	Allihn Condenser, 300 mm
-07	Solenoid
-08	Flex-O-Pulse Timer (Wired for use)
-09	Socket Adapter with stopcock and hose connection
-10	#18 Ball and Socket clamp (Not pictured)

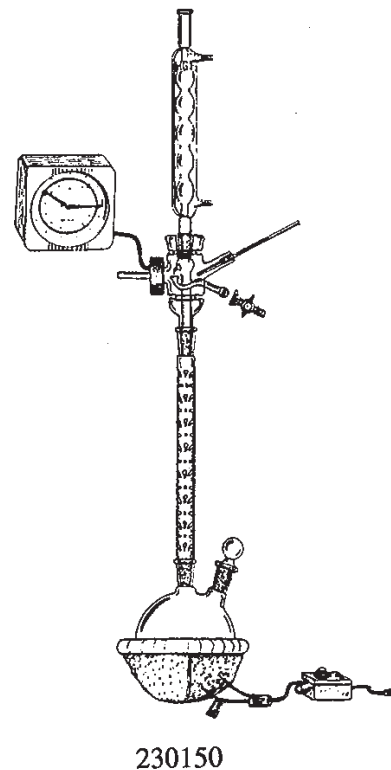

# 230180

DITHIOCARBAMATE APPARATUS.

(Also HGF#018352)

CODE	DESCRIPTION
-00	COMPLETE
-01	Flask, 500 ml, 3 neck
-02	Air inlet tube
-03	Condenser
-04	Dropping Funnel 60 ml
-05	Trap with glass beads
-06	Connecting tube
-07	Trap with stopcock and glass beads
-08	Adapter
-09	#28 Ball & Socket clamp (4 ea)
-10	Stopper 24/40

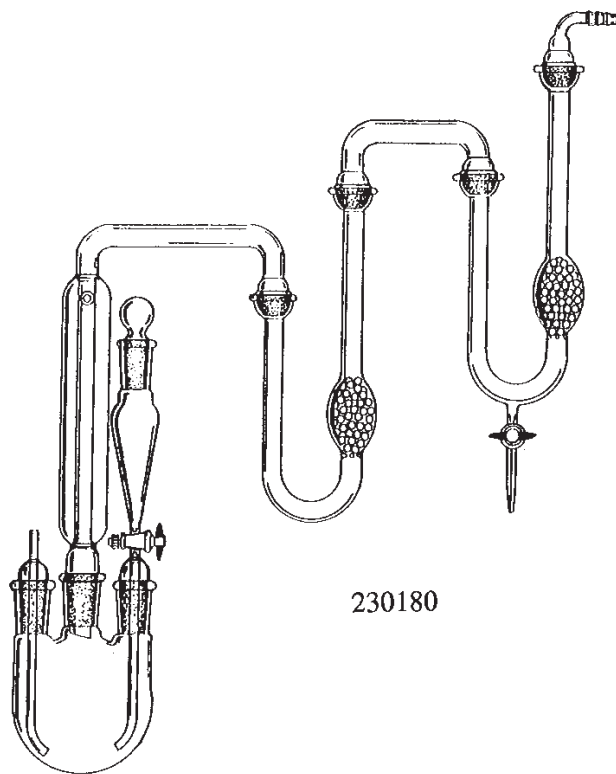

230180

## 230230

(Formerly HGF#018401)

EXTRACTION APPARATUS, LIQUID-LIQUID, 45/50. Extractor body designed for EPA priority pollutant samples where the extracting solvent is heavier than water. Return tube has a 4 mm stopcock.

CODE	DESCRIPTION
------	-------------

-00	COMPLETE
-01	Flask, 250 ml, 24/40
-02	Extractor, 45/50
-03	Condenser, 45/50

## 230240

(Formerly HGF#018400)

EXTRACTION APPARATUS, LIQUID-LIQUID, 55/50. Same as 230230 but with 55/50 joints.

CODE	DESCRIPTION
------	-------------

-00	COMPLETE
-01	Flask, 250 ml, 24/40
-02	Extractor, 55/50
-03	Condenser, 55/50

(PLEASE CALL FOR QUOTES ON LIQUID-LIQUID EXTRACTIONS  
REQUIRING LIGHTER THAN WATER SOLVENTS)

## 230245

EXTRACTOR, LIQUID-LIQUID WITHOUT STOPCOCK ON RETURN TUBE.

CODE	DESCRIPTION
------	-------------

-01	Extractor with 45/50 top joint
-02	Extractor with 55/50 top joint

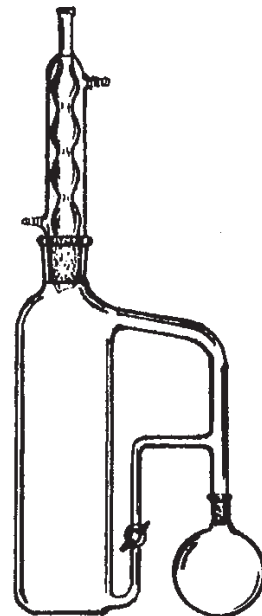

230230 230240

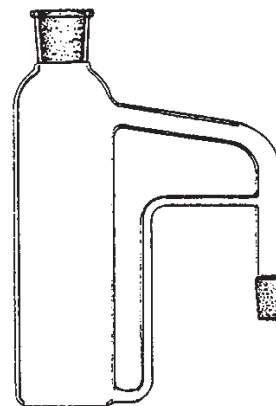

230245

230250



## 230250

EXTRACTION APPARATUS, SOXHLET. Used for the continuous extraction of solids with a suitable solvent.

CODE	DESCRIPTION
------	-------------

-01	COMPLETE - 125 ml Flask, Extractor and Condenser, 34/45
-01P1	125 ml F.B. Boiling Flask, 24/40
-01P2	Extractor, 34/45
-01P3	Condenser, 34/45
-02	COMPLETE - 250 ml Flask, Extractor and Condenser, 45/50
-02P1	250 ml F.B. Boiling Flask, 24/40
-02P2	Extractor, 45/50
-02P3	Condenser, 45/50
-03	COMPLETE - 500 ml Flask, Extractor and Condenser, 55/50
-03P1	500 ml F.B. Boiling Flask, 24/40
-03P2	Extractor, 55/50
-03P3	Condenser, 55/50
-04	COMPLETE - 1000 ml Flask, Extractor and Condenser, 71/60
-04P1	1000 ml F.B. Boiling Flask, 29/42
-04P2	Extractor, 71/60
-04P3	Condenser, 71/60

(PLEASE CALL FOR QUOTE ON LARGER SIZED SOXHLET EXTRACTORS)

230251



## 230251

EXTRACTOR, SOXHLET (MODIFIED) Soxhlet Extractor, modified design, allows extraction at the boiling point of the solvent. Breakage is reduced by the elimination of external vapor and siphon tubes.

CODE	DESCRIPTION
------	-------------

-01	Extractor, 34/45 Top joint, 24/40 Btm joint
-02	Extractor, 45/50 Top joint, 24/40 Btm joint
-03	Extractor, 55/50 Top joint, 24/40 Btm joint

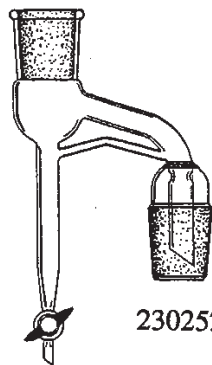

230252

## 230252

(Formerly HGF#18629)

EXTRACTION APPARATUS, SOXHLET/DEAN-STARK RECEIVER § 55/50. Combined with standard Soxhlet Extractor set up for a single process to remove water, CDD'S and CDF'S from the same wet sample. Use with 230250-03.

CODE
------

-01
-----

## 230255

EXTRACTION, THIMBLE. For use in Soxhlet Extractions. Supplied with extra-coarse frits.

CODE	DIAMETER OF BODY	OVERALL HEIGHT
-01	25 mm	85 mm
-02	35 mm	90 mm
-03	45 mm	130 mm
-04	57 mm	150 mm

(OTHER FRIT POROSITIES AVAILABLE)



230255

## 230257

(Formerly HGF#018625)

EXTRACTION, THIMBLE. Air quality testing. Fits 71/60 size Soxhlet Extractor. Solid construction with stainless steel screens, nuts, and bolts. Screens can be removed for cleaning or replacement.

CODE

-01

230257

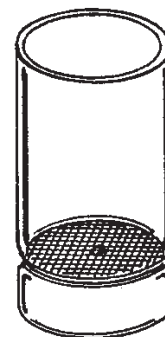

## 230260

EXTRACTION APPARATUS - MODIFIED OFFSET EXTRACTOR. For working with large volumes, body is 95 mm inner diameter. Design allows for easy access to sample.

CODE	DESCRIPTION
-00	COMPLETE SET-UP
-01	Flask, 5000 ml, 29/42
-02	Off-Set Extractor
-03	Condenser, Allihn 45/50
-04	Ground cover plate
-05	Spring leash
-06	Stainless steel screen

(PLEASE CALL FOR QUOTE ON LARGER SIZED OFFSET EXTRACTORS)

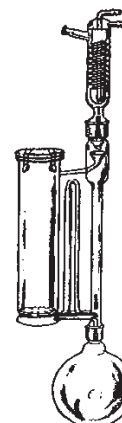

230260

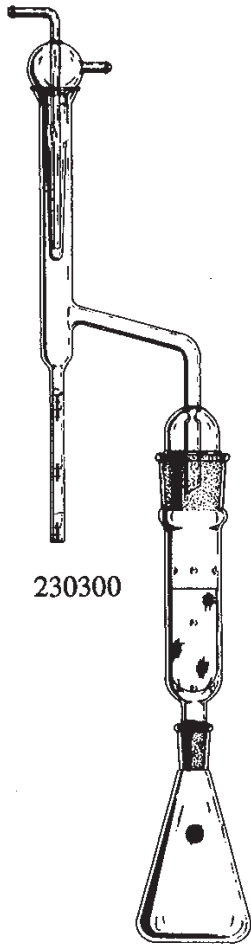

230300



230320

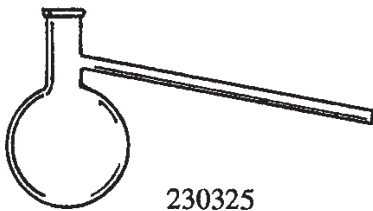

230325

### 230300

EXTRACTION APPARATUS. Treated Wood. Conforms to design approved by AWPA (Standard A6-59), Western Electric Co., REA, and others. 95 mm wire basket will accommodate the 3" borings required for determination of net retention on pilings.

CODE	DESCRIPTION
------	-------------

- |     |                              |
|-----|------------------------------|
| -00 | COMPLETE - PARTS 1-5         |
| -01 | Condenser                    |
| -02 | 10 ml Graduated Trap         |
| -03 | Extraction Tube, 55/50       |
| -04 | 95 mm Stainless steel basket |
| -05 | 500 ml Flask, 24/40          |

ACCESSORIES FOR ABOVE

- |     |  |
|-----|--|
| -06 | Weighing bottle, with top, for 95 mm basket                          |
| -07 | 125 mm Stainless steel basket  |
| -08 | Weighing bottle, with top, for 125 mm basket                         |
| -09 | Weighing bottle, Top only, fits 95 mm and 125 mm                     |
| -10 | 10 ml Graduated trap, but with stopcock at bottom of graduated tube. |

### 230320

CONDENSER, Asphalt. (ASTM D402, AASHO T78). A simple tube with flared end for use with distillation apparatus for cut-back asphaltic products. Useful in wood treatment laboratories. 360 mm long.

CODE
------

- |     |
|-----|
| -01 |
|-----|

### 230325

DISTILLING FLASK, CHURCH. For the distillation of Bituminous materials suitable for road treatment. (ASTM D20, D246, D402, D2569).

CODE	DESCRIPTION
------	-------------

- |     |        |
|-----|--------|
| -01 | 300 ML |
| -02 | 500 ML |

ASTM D2041 RESIDUAL PRESSURE MANOMETER  
SEE HGF PART# 393000

## 232000

EXTRACTION APPARATUS, DEAN-STARK. Primarily used for the determination of oil and brine saturation in core samples. The apparatus comfortably accommodates a 2" core sample and incorporates a rugged stainless steel mesh sample support.

CODE	DESCRIPTION	FORMER HGF#
-00	COMPLETE APPARATUS, 5-PARTS	012560
-01	Boiling Flask, 1000 ml	
-02	Extractor, 71/60 top joint, 24/40 bottom joint	
-03	Receiver, 20 ml	
-04	Condenser, Allihn, 300 mm	
-05	Drying Tube	

You may custom design your own Dean-Stark apparatus by ordering the various components in other sizes or capacities to fit your particular application.

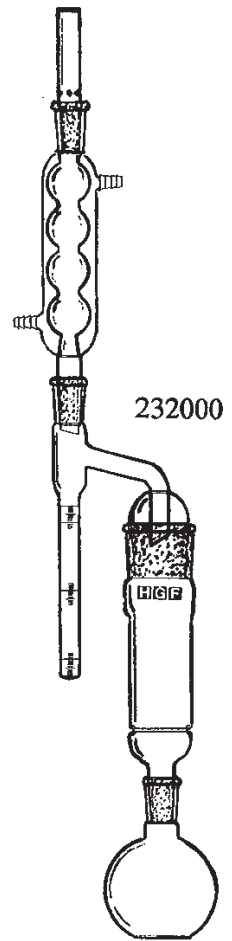

## 232025

MODIFIED DEAN-STARK APPARATUS. This is a modified design core extraction apparatus in which the core is immersed in liquid solvent to improve cleaning. It is a more efficient version of the standard Dean-Stark apparatus, although more fragile. It incorporates a soxhlet-type syphoning extractor body as the sample holder, and highly efficient Allihn-type condenser. The apparatus accommodates a 2" core sample.

CODE	DESCRIPTION	FORMER HGF#
-00	COMPLETE APPARATUS, 5-PARTS	012570
-01	Boiling Flask, 1000 ml	
-02	Soxhlet Extractor, 71/60 Top joint, 24/40 Bottom joint	
-03	Receiver, 20 ml	
-04	Condenser, Allihn, 300 mm	
-05	Drying Tube	

You may also custom design your own Modified Dean-Stark apparatus by ordering the various components in other sizes or capacities to fit your particular application.

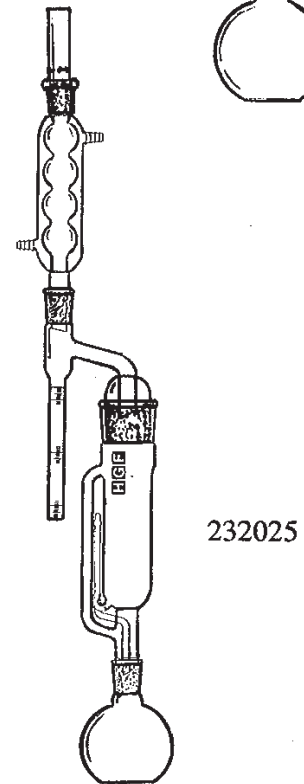

232050

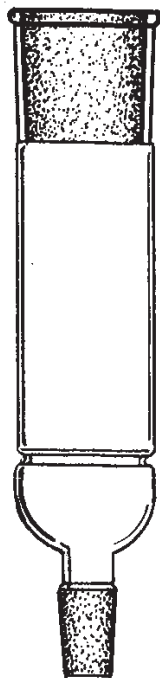

## 232050

EXTRACTOR BODY. Designed with a stainless steel mesh sample support.

CODE	TOP JOINT SIZE	LOWER JOINT SIZE	APPROX. I.D. (MM)	MAX. SAMPLE HEIGHT (INCHES)
-01	50/50	24/40	45	6
-02	55/50	24/40	50	6
-03	71/60	24/40	65	7
-04	103/60	24/40	95	7
-05	115/60	45/50	105	8
-06	135/60	45/50	125	8 1/2
-07	145/60	45/50	135	10

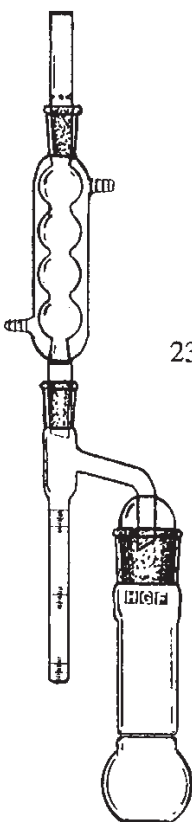

232100

## 232100

BAILEY-WALKER EXTRACTION APPARATUS (UP TO 1 1/2" CORE). This apparatus is designed for cleaning core samples prior to core floods or test for relative permeability. The solid core sample (or an extraction thimble containing the sample) is supported by a stainless steel mesh disc.

CODE	DESCRIPTION
-00	COMPLETE APPARATUS, 4-PARTS
-01	Bailey-Walker Flask, 250 ml, 45/50
-02	Dean-Stark Receiver, 10 ml
-03	Condenser, Allihn, 300 mm
-04	Drying Tube, 24/40

## 232150

BAILEY-WALKER FLASK. Designed with a stainless steel mesh sample support.

CODE	JOINT SIZE	FLASK SIZE (ML)	APPROX. I.D. (MM)	MAX. SAMPLE HEIGHT (INCHES)
-01	34/45	125	28	5
-02	45/50	250	40	5
-03	45/50	500	40	6
-04	55/50	250	50	5
-05	55/50	500	50	6

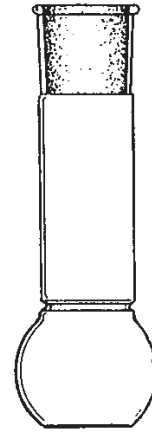

232150

## 233000

AMOTT WETABILITY CELL (IMBITION TUBE)

CODE	CALIBRATION	APPROX. I.D.	FORMER HGF #
-01	8 ml x 1/10 ml Div.	2"	967590
-02	10 ml x 1/10 ml Div.	2"	018373-10
-03	15 ml x 1/10 ml Div.	2"	018373-15
-04	20 ml x 1/10 ml Div.	2 1/4"	018374

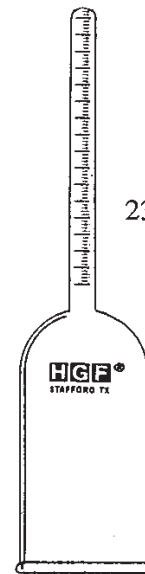

233000

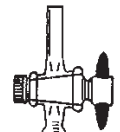

## 233100

AMOTT WETABILITY CELL (IMBITION CELL) WITH STOPCOCK.

CODE	CALIBRATION	APPROX. I.D.
-01	8 ml x 1/10 ml Div.	2"
-02	10 ml x 1/10 ml Div.	2"

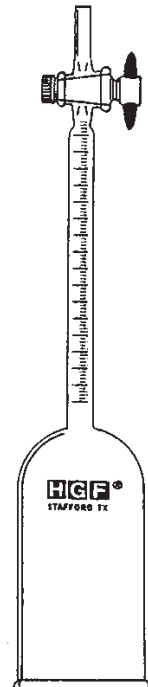

233100

### RECEIVING FLASKS & TUBES

These receiving flasks and tubes are for use in collecting samples from relative permeability of EOR core floods. The tubes and flasks necks are graduated in milliliters to allow the volumes of oil and brine to be measured.

The flask-shaped vessels are used when the anticipated brine volume of the samples is large compared to the volume of oil. The tubes can be used for any ratio of oil volume to brine volume.

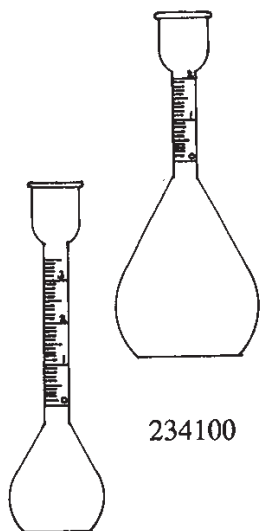

### 234100

#### RECEIVING FLASKS.

CODE	NOMINAL CAPACITY (ML)	GRADUATIONS ON NECK
-01	10	0 TO +4.0 X 1/10 ml Div.
-02	25	0 TO +3.5 X 1/10 ml Div.
-03	50	0 TO +3.0 X 1/10 ml Div.
-04	100	0 TO +2.0 X 1/10 ml Div.
-05	200	0 TO +4.0 X 1/10 ml Div.
-06	500	0 TO +4.5 X 1/10 ml Div.
-07	1000	0 TO +5.0 X 1/10 ml Div.

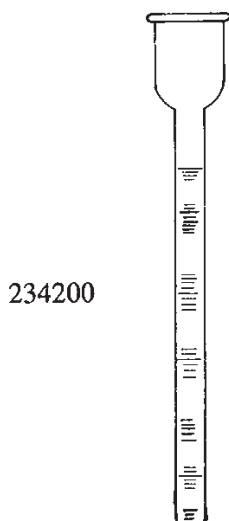

### 234200

#### RECEIVING TUBES.

CODE	CAPACITY (ML)	DIVISIONS (ML)
-01	2	1/10
-02	3	1/10
-03	4	1/10
-04	6	1/10
-05	10	2/10
-06	15	2/10
-07	20	2/10
-08	25	1/2

DON'T SEE WHAT YOU WANT? PLEASE  
GIVE US A CALL HGF HAS OVER 5000  
DRAWINGS OF STANDARD AND CUSTOM  
GLASSWARE ON FILE!

## 255040

FILTER, FLASK. Heavy walled flask with 40/35 inner joint.

CODE	DESCRIPTION
------	-------------

-01	1000 ml
-02	2000 ml
-03	4000 ml

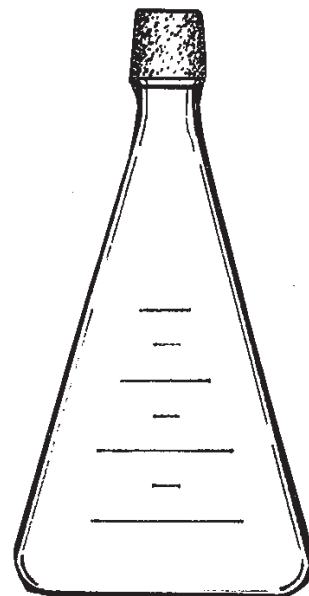

250040

## 250060

FILTER STICK ASSEMBLY (ASTM D721) Used in the determination of oil content in petroleum waxes. With 24/40 joints and 10 mm fritted disc. All Filter Sticks are tested for proper porosities before shipping.

CODE	DESCRIPTION
------	-------------

-00	COMPLETE
-01	Filter Stick only
-02	Test Tube only

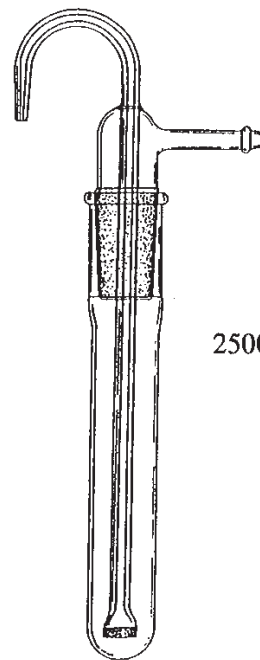

250060

## CUSTOMIZE YOUR FLASK

PLEASE SPECIFY WHEN ORDERING FLASKS IF ANY OF THESE OPTIONS ARE DESIRED.  
THESE OPTIONS CAN BE ADDED TO ALMOST ANY FLASK AT MINIMAL CHARGE.

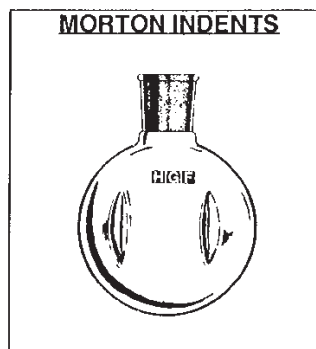
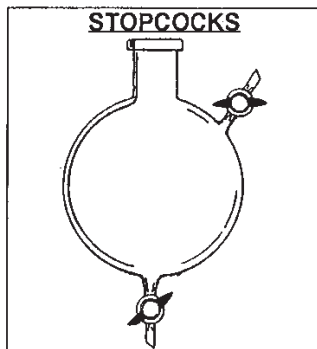
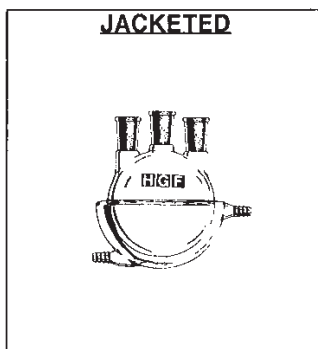
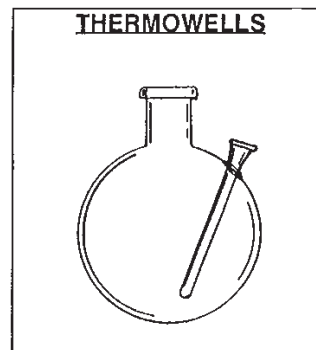
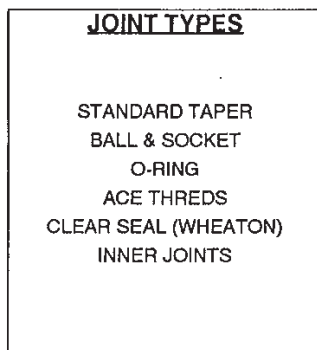
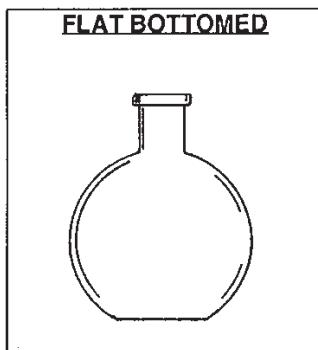

### 255010

FLASK, Single Neck with 3 outer

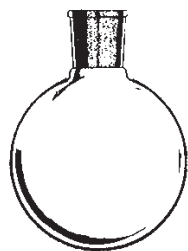

255010

CODE	CAPACITY (ML)	JOINT SIZE	CODE	CAPACITY (ML)	JOINT SIZE
-01	50	14/20	-17	1000	34/45
-02	50	19/22	-18	1000	45/50
-03	50	24/40	-19	2000	24/40
-04	100	14/20	-20	2000	29/42
-05	100	19/22	-21	2000	34/45
-06	100	24/40	-22	2000	45/50
-07	125	24/40	-23	3000	24/40
-08	125	29/42	-24	3000	29/42
-09	250	19/22	-25	3000	45/50
-10	250	24/40	-26	3000	55/50
-11	250	29/42	-27	5000	24/40
-12	500	19/22	-28	5000	29/42
-13	500	24/40	-29	5000	45/50
-14	500	29/42	-30	5000	55/50
-15	1000	24/40	-31	12,000	45/50
-16	1000	29/42	-32	12,000	55/50
			-33	12,000	71/60

## 255020

FLASK, Two neck, Vertical necks, with  $\frac{3}{4}$  outer joints.

CODE	CAPACITY (ML)	CENTER NECK	SIDE NECK
-01	100	24/40	24/40
-02	250	24/40	24/40
-03	250	29/42	24/40
-04	500	24/40	24/40
-05	500	29/42	24/40
-06	500	34/45	24/40
-07	1000	24/40	24/40
-08	1000	29/42	24/40
-09	1000	34/45	24/40
-10	1000	45/50	24/40
-11	2000	24/40	24/40
-12	2000	29/42	24/40
-13	2000	45/50	24/40
-14	5000	45/50	24/40
-15	12,000	45/50	24/40



255020

## 255030

FLASK, Three Neck, Vertical necks, with  $\frac{3}{4}$  outer joints.

CODE	CAPACITY (ML)	CENTER NECK	SIDE NECKS
-01	250	24/40	24/40
-02	250	29/42	24/40
-03	500	24/40	24/40
-04	500	29/42	24/40
-05	1000	24/40	24/40
-06	1000	29/42	24/40
-07	1000	45/50	24/40
-08	2000	24/40	24/40
-09	2000	29/42	24/40
-10	2000	34/45	24/40
-11	2000	45/50	24/40
-12	3000	24/40	24/40
-13	3000	29/42	24/40
-14	3000	34/45	24/40
-15	3000	45/50	24/40
-16	5000	24/40	24/40
-17	5000	29/42	24/40
-18	5000	45/50	24/40
-19	5000	55/50	24/40
-20	12,000	45/50	24/40
-21	12,000	55/50	24/40
-22	22,000	45/50	24/40
-23	22,000	55/50	24/40

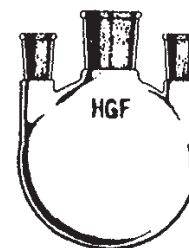

255030

## 255040

FLASK, Four neck, Vertical necks, with  $\bar{3}$  outer joints.

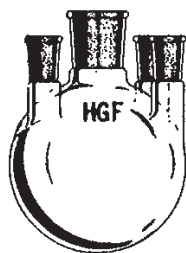

255040

CODE	CAPACITY (ML)	CENTER NECK	SIDE NECKS
-01	250	24/40	24/40
-02	500	24/40	24/40
-03	500	29/42	24/40
-04	1000	24/40	24/40
-05	1000	29/42	24/40
-06	1000	34/45	24/40
-07	1000	45/50	24/40
-08	2000	24/40	24/40
-09	2000	29/42	24/40
-10	2000	34/45	24/40
-11	2000	45/50	24/40
-12	3000	24/40	24/40
-13	3000	29/42	24/40
-14	3000	45/50	24/40
-15	5000	24/40	24/40
-16	5000	29/42	24/40
-17	5000	45/50	24/40
-18	12,000	45/50	24/40
-19	22,000	45/50	24/40

## 255050

FLASK, Five neck, Vertical necks, with  $\bar{3}$  outer joints.

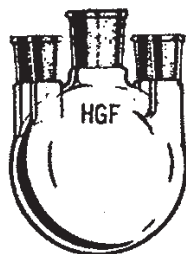

255050

CODE	CAPACITY (ML)	CENTER NECK	SIDE NECKS
-01	1000	24/40	24/40
-02	1000	29/42	24/40
-03	2000	24/40	24/40
-04	2000	29/42	24/40
-05	2000	45/50	24/40
-06	3000	24/40	24/40
-07	3000	29/42	24/40
-08	3000	45/50	24/40
-09	5000	24/40	24/40
-10	5000	29/42	24/40
-11	5000	45/50	24/40

(PLEASE CALL FOR OTHER SIZES NOT LISTED)

## 255190

FLASK, REACTION, Cylindrical with 4" I.D. ground flanged neck.

CODE	CAPACITY (ML)	APPROX. OVERALL HEIGHT (MM)
-01	500	100
-02	1000	150
-03	1500	205
-04	2000	260

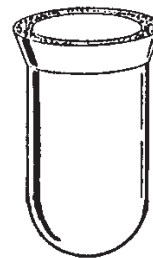

255190

## 255200

FLASK, REACTION, with 4" I.D. ground flanged neck.

CODE	CAPACITY (ML)
-01	3000
-02	5000
-03	12,000
-04	22,000



255200

## 255300

FLASK HEAD, Three necks with 4" ground flange.

CODE	CENTER NECK	SIDE NECKS
-01	24/40	24/40
-02	29/42	24/40
-03	45/50	24/40



255300

## 255310

FLASK HEAD, Four necks with 4" ground flange.

CODE	CENTER NECK	SIDE NECKS
-01	24/40	24/40
-02	29/42	24/40
-03	45/50	24/40



255310

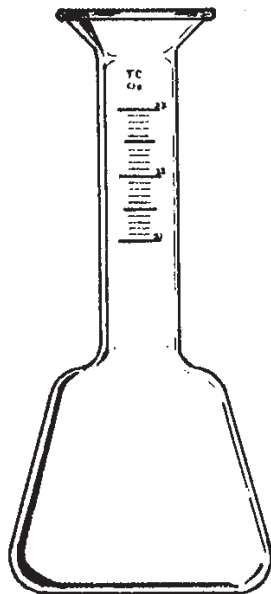

256600

## 256600

FLASK, CALIBRATING. Useful for determining overfill or underfill of containers. Graduated in ounces and subdivided into 1/10 ounce divisions. Neck on all sizes is approximately 35 mm I.D. to allow for rapid filling and draining. Calibrated "TO CONTAIN."

CODE	CAPACITY (OZ)	GRADUATED (OZ)
-01	6	5 - 7
-02	7	6 - 8
-03	8	7 - 9
-04	10	9 - 11
-05	12	11 - 13
-06	16	15 - 17
-07	18	17 - 19
-08	32	31 - 33
-09	46	45 - 47
-10	48	47 - 49
-11	64	63 - 65
-12	96	95 - 97
-13	128	127 - 129

## 256650

FLASK, CALIBRATING. Precision calibrated for accurate, fine adjusting of container filling machines. Fabricated from heavy borosilicate glass. Graduations are in 1 ml subdivisions, and the "ounce" calibration mark at the rated capacity completely encircles the neck for fast, accurate reading. I.D. of neck is approximately 20 mm.

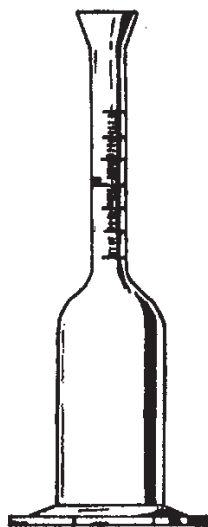

256650

CODE	CAPACITY (OZ)	GRADUATED (ML)	NOTES
-01	2	50 - 75	Cylinder
-02	3	75 - 100	Cylinder
-03	4	105 - 135	
-04	6	165 - 195	
-05	7	190 - 220	
-06	8	220 - 250	
-07	10	280 - 310	
-08	11	310 - 340	
-09	12	340 - 370	
-10	16	460 - 490	
-11	18	520 - 550	
-12	22	635 - 665	
-13	40	1160 - 1210	
-14	46	1340 - 1390	No base
-15	64	1870 - 1930	No base

## 260005

Funnel, Buchner-Type, with fritted disc.

CODE	VOLUME (ML)	FRIT POROSITY
-01	60	Extra coarse
-02	60	Coarse
-03	60	Medium
-04	60	Fine
-05	150	Extra coarse
-06	150	Coarse
-07	150	Medium
-08	150	Fine
-09	350	Extra coarse
-10	350	Coarse
-11	350	Medium
-12	350	Fine
-13	600	Extra coarse
-14	600	Coarse
-15	600	Medium
-16	600	Fine
-17	2000	Extra coarse
-18	2000	Coarse
-19	2000	Medium
-20	2000	Fine
-21	3000	Extra coarse
-22	3000	Coarse
-23	3000	Medium
-24	3000	Fine



260005

## 260100

FUNNEL, Powder. Useful in pouring powders or liquids into 24/40 jointed containers.

CODE	TOP FLAIR (MM) Approx.
-01	45
-02	75
-03	100

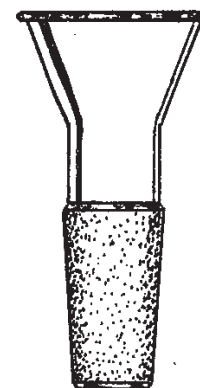

260100

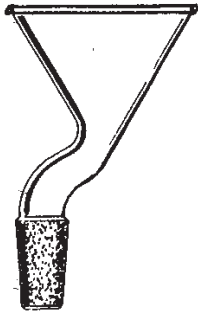

260110

### 260110

FUNNEL, Powder Off-set. Useful for pouring powders or liquids into multi-neck flasks. 24/40 inner joint.

CODE TOP FLAIR  
(MM) Approx.

-01	45
-02	75
-03	100

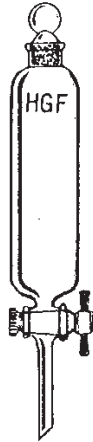

260135

### 260135

FUNNEL, Separatory, Cylindrical, Teflon stopcock.

CODE CAPACITY (ML) STOPPER SIZE STOPCOCK (MM)

-01	60	#16	2
-02	125	#22	2
-03	250	#22	2
-04	500	#27	4

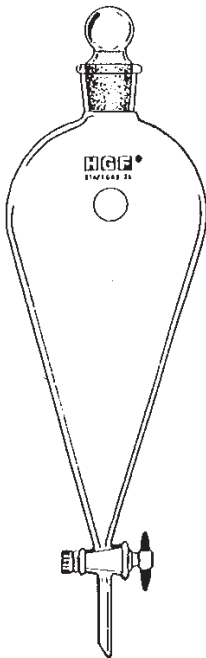

260145

### 260145

FUNNEL, Separatory, Squibb, Pear-Shaped, Teflon stopcock.

CODE CAPACITY (ML) STOPPER SIZE STOPCOCK (MM)

-01	60	#16	2
-02	125	#22	2
-03	250	#22	4
-04	500	#27	4
-05	1000	#27	4
-06	2000	#38	6



261105

### 261105

FUNNEL, Separatory, Cylindrical. With a stopper joint at top, and 24/40 inner joint at bottom, and with Teflon stopcock.

CODE CAPACITY (ML) STOPPER SIZE STOPCOCK (MM)

-01	60	#16	2
-02	125	#22	2
-03	250	#22	4
-04	500	#27	4
-05	1000	#27	4
-06	2000	#27	4

## 261115

FUNNEL, Separatory, Cylindrical. Same as 261105 except graduated.

CODE	CAPACITY (ML)	STOPPER SIZE	STOPCOCK (MM)	GRADUATED DIV. (ML)
-01	60	#16	2	1
-02	125	#22	2	1
-03	250	#22	2	2
-04	500	#27	4	5
-05	1000	#27	4	10
-06	2000	#27	4	20

261115



## 261125

FUNNEL, Addition, Cylindrical. With pressure equalizing tube at side with a stopper joint on top and a 24/40 inner joint at bottom. Teflon stopcock.

CODE	CAPACITY (ML)	STOPPER SIZE	STOPCOCK (MM)
-01	60	#16	2
-02	125	#22	2
-03	250	#22	2
-04	500	#27	4
-05	1000	#27	4
-06	2000	#27	4

261125



## 261135

FUNNEL, Addition, Cylindrical. Same as 261125 except graduated.

CODE	CAPACITY (ML)	STOPPER SIZE	STOPCOCK (MM)	GRADUATED DIV. (ML)
-01	60	#16	2	1
-02	125	#22	2	1
-03	250	#22	2	2
-04	500	#27	4	5
-05	1000	#27	4	10
-06	2000	#27	4	20

261135

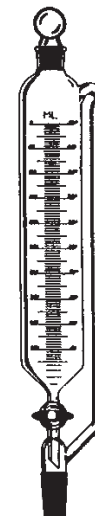

## 263225

FREEZE POINT APPARATUS (ASTM D2386). For use in the test for freezing point of aviation fuels.

CODE	DESCRIPTION
-00	Dewar Flask and freeze point test tube
-01	Test Tube only 30 mm O.D., 20 x 235 I.D.
-02	Dewar Flask 100 mm O.D., 70 x 280 I.D.

263225

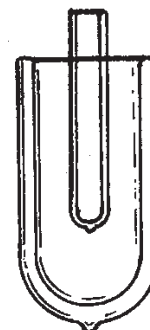

## 271000

GAS COLLECTING TUBE, Plain. With Glass stopcocks.

CODE	APPROX. CAP'Y (ML)	STOPCOCK (MM)
-01	60	2
-02	125	2
-03	250	4
-04	500	4



271000

## 271005

GAS COLLECTING TUBE, Plain. With Teflon stopcocks.

CODE	APPROX. CAP'Y (ML)	STOPCOCK (MM)
-01	60	2
-02	125	2
-03	250	4
-04	500	4



271005

## 271010

GAS COLLECTING TUBE. With Glass stopcocks and with side port tooled for 1/4" septum.

CODE	APPROX. CAP'Y (ML)	STOPCOCK (MM)
-01	60	2
-02	125	2
-03	250	4
-04	500	4



271010

## 271015

GAS COLLECTING TUBE. With Teflon stopcocks and with side port tooled for 1/4" septum.

CODE	APPROX. CAP'Y (ML)	STOPCOCK (MM)
-01	60	2
-02	125	2
-03	250	4
-04	500	4



271015

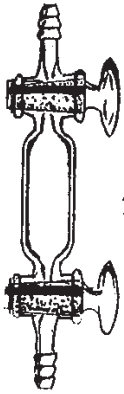

271050

### 271050

GAS COLLECTING TUBE, Micro. With 2 mm Glass stopcocks and hose connections.

CODE	CAPACITY APPROX. (ML)
-01	10
-02	20

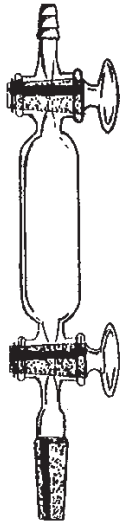

271060

### 271060

GAS COLLECTING TUBE, Micro. With 2 mm Glass stopcocks, with a 14/35 inner ground joint at one end, and with hose connection on other end.

CODE	CAPACITY APPROX. (ML)
-01	25



310500

### 310500

IMPINGER, MIDGET. The orifice at the bottom of the impinger tube passes .09 - .11 CFM of air at 12" H<sub>2</sub>O. Designed for sampling of small air volumes with a low jet velocity. The bottle portion is graduated from 5 to 30 ml. Adaptable to any air sample that runs at a steady 0.1 CFM flow rate. Ground joint is 24/40.

CODE	DESCRIPTION
-00	COMPLETE
-01	Impinger tube only, with 24/40 inner joint
-02	Bottle only, with 24/40 outer joint



310510

### 310510

IMPINGER, MIDGET. With 1/2" joints. Identical to 310500, except with 1/2" ball joints on inlet and outlet.

CODE	DESCRIPTION
-00	COMPLETE
-01	Impinger tube only, with 24/40 inner joint
-02	Bottle only, with 24/40 outer joint

### 310600

IMPINGER, GREENBURG-SMITH. Used for the determination of dust concentration in air or other gases. Bottle part is graduated at 100, 250 and 500 ml and ground joint is  $\text{3/4}$  45/50.

CODE	DESCRIPTION
-00	COMPLETE
-01	Impinger tube only, with $\text{3/4}$ 45/50 inner joint
-02	Bottle only, with $\text{3/4}$ 45/50 outer joint

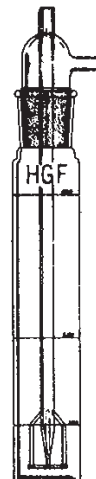

310600

### 310610

IMPINGER, GREENBURG-SMITH, with ball joints. Bottle is graduated at 100, 250, and 500 ml and ground joint is  $\text{3/4}$  45/50.

CODE	DESCRIPTION
-00	COMPLETE with 18/9 ball joints on dispersion tube
-01	Dispersion tube only, 18/9 ball joint
-02	Bottle only 500 ml, 45/50
-10	COMPLETE with 28/15 ball joints on dispersion tube
-11	Dispersion tube only, 28/15 ball joint
-12	Bottle only 500 ml, 45/50

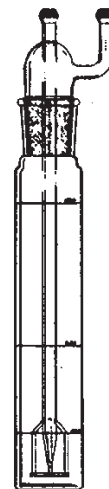

310610

### 310615

IMPINGER, GREENBURG-SMITH, Modified. Same as 310610, except without Impinger plate at lower end of center tube. Center tube is wide open.

CODE	DESCRIPTION
-00	COMPLETE with 18/9 ball joints on dispersion tube
-01	Dispersion tube only, 18/9 ball joints
-02	Bottle only 500 ml, 45/50
-10	COMPLETE with 28/15 ball joints on dispersion tube
-11	Dispersion tube only, 28/15 ball joints
-12	Bottle only 500 ml, 45/50

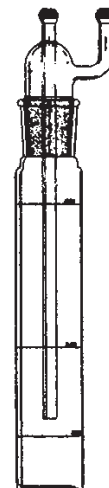

310615

SEE 160719 ADAPTER ON PAGE A-11  
FOR MAKING CONNECTIONS BETWEEN  
IMPINGERS AND BUBBLERS



390110

### 390110

GAS MANIFOLD. For portable Orsat gas analysis apparatus.

CODE

-01



390120

### 390120

GAS MANIFOLD. General utility with one T-bore stopcock and four straight bore stopcocks.

CODE

-01

### 390160

MANIFOLD, VACUUM. Three, four, and five stopcock ports. Designed for vacuum applications up to  $5 \times 10^{-7}$  Torr. Teflon plug with three o-rings. Control knob is made of a special high performance polymer blend of TFE and PPS and will withstand temperatures up to 230°C. Valves are available with standard Viton o-rings (brown) or new Teflon coated Viton o-rings (blue). Sidearms on stopcocks are 1/2" outside diameter.

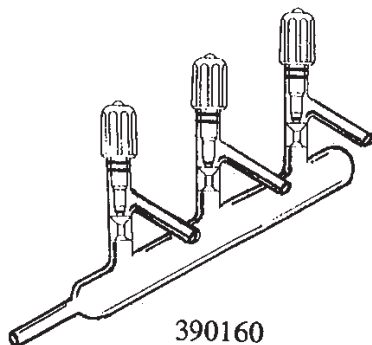

390160

CODE

DESCRIPTION

CODE	DESCRIPTION
-01	3 Ports, 0-8 mm stopcocks, Viton O-rings (Brown)
-02	3 Ports, 0-8 mm stopcocks, Teflon coated O-rings (Blue)
-03	4 Ports, 0-8 mm stopcocks, Viton O-rings (Brown)
-04	4 Ports, 0-8 mm stopcocks, Teflon coated O-rings (Blue)
-05	5 Ports, 0-8 mm stopcocks, Viton O-rings (Brown)
-06	5 Ports, 0-8 mm stopcocks, Teflon coated O-rings (Blue)

(ALSO AVAILABLE IN 0-4 MM AND 0-12 HI VACUUM STOPCOCKS)

### 392000

GAUGE, Vacuum or Pressure. Open end U-tube mounted on a wooden panel and with a millimeter scale. Tube may be filled with mercury or water. Supplied empty.

CODE SCALE LGTH (MM)

---

-01	300
-02	600
-03	1000



392000

### 393000

GAUGE, VACUUM, MANOMETER. Closed-end mercury filled U-tube with a constriction near the bottom to prevent damage if the vacuum is abruptly released. U-tube is joined to base tube by  $\frac{1}{8}$  10/30 ground joint. Base tube has  $\frac{1}{8}$  2 mm stopcock and heavy walled hose connections. Wooden base has an adjustable mm scale and is cut out at ends of base tube so that the glass tube is not exposed to excessive breakage. Can be used as residual pressure manometer now mandatory for ASTM D2041.

CODE	DESCRIPTION
-00	COMPLETE
-01	Base tube only, with stopcock
-02	U-tube only, filled with mercury
-03	Wooden stand only, with clamps

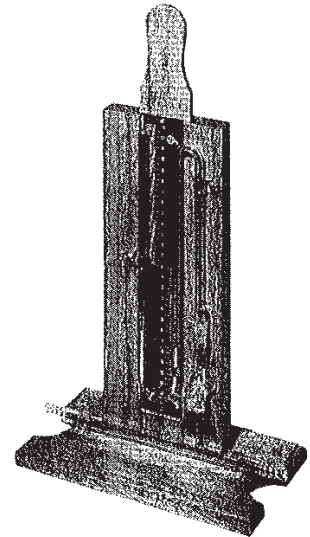

393000

## 430100

OXIDATION CELL ASTM D943. Apparatus used in the test for oxidation characteristics of inhibited steam-turbine oils. IP157

CODE	DESCRIPTION
------	-------------

-00	COMPLETE, 3 Parts
-01	Mushroom condenser only
-02	Test tube only
-03	Air delivery tube only

430100



## 450800

PIPET, AUTOMATIC, "TILT-A-MATIC" to dispense a repeatable volume. Complete unit consists of a flask, pipet head, and pair of stainless steel springs.

CODE	COMPLETE	CODE	HEAD ONLY	CODE	FLASK ONLY
------	----------	------	-----------	------	------------

-01	5 ML	-20	5 ML	-40	500 ML
-02	10 ML	-21	10 ML	-40	500 ML
-03	15 ML	-22	15 ML	-40	500 ML
-04	20 ML	-23	20 ML	-40	500 ML
-05	25 ML	-24	25 ML	-40	500 ML
-06	30 ML	-25	30 ML	-40	500 ML
-07	35 ML	-26	35 ML	-40	500 ML
-08	40 ML	-27	40 ML	-40	500 ML
-09	50 ML	-28	50 ML	-40	500 ML
-10	60 ML	-29	60 ML	-41	1000 ML
-11	75 ML	-30	75 ML	-41	1000 ML
-12	90 ML	-31	90 ML	-41	1000 ML
-13	100 ML	-32	100 ML	-41	1000 ML
				-42	2000 ML

(FOR SPRINGS SEE PART # 510600-03)

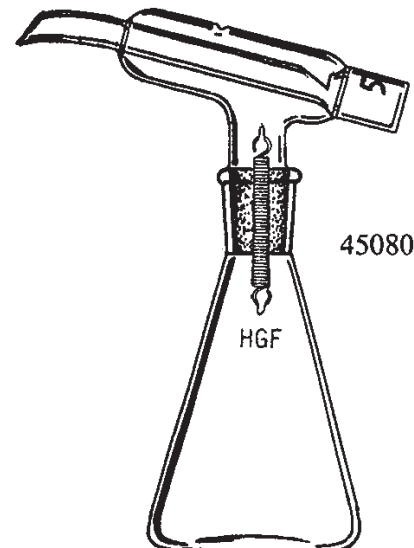

450800

## 500010

NEEDLE SPARGE SAMPLERS. For purging foaming samples, solids and soils. With 1/2" (12.7 mm) outside diameter stems.

CODE	DESCRIPTION	FORMER HGF#
------	-------------	-------------

-01	5 ml, 137 mm O.A.L. with 1/2" Ground stem	018571
-02	5 ml, 137 mm O.A.L. with 1/2" Unground stem	018324
-03	25 ml, 137 mm O.A.L. with 1/2" Ground stem	018496
-04	25 ml, 137 mm O.A.L. with 1/2" Unground stem	018496-UG
-05	25 ml, 197 mm O.A.L. with 1/2" Ground stem	018325
-06	25 ml, 197 mm O.A.L. with 1/2" Unground stem	018325-UG

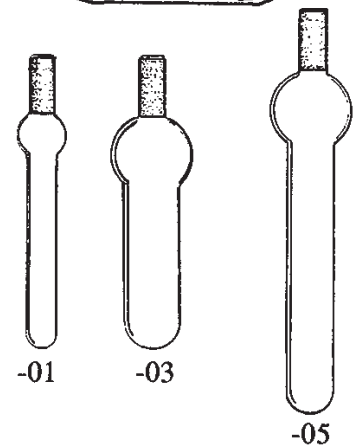

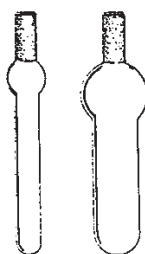

500020

## 500020

NEEDLE SPARGE SAMPLERS. With 12 mm stems.

CODE	DESCRIPTION	FORMER HGF#
-01	5 ml, 137 mm O.A.L. with 12 mm Ground stem	n/a
-02	5 ml, 137 mm O.A.L. with 12 mm Unground stem	018857
-03	25 ml, 137 mm O.A.L. with 12 mm Ground stem	018663
-04	25 ml, 137 mm O.A.L. with 12 mm Unground stem	019074

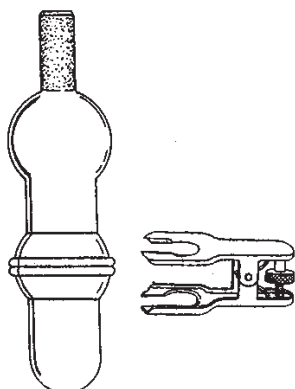

500030

## 500030

NEEDLE SPARGE SAMPLER, Separable design allows the lower portion of the sampler to be removed for cleaning. The two piece construction is held together with a stainless steel clamp and a Viton o-ring to make a leak proof seal.

CODE	DESCRIPTION
-01	COMPLETE, 4-Part Sampler with 1/2" (12.7) ground stem
-01P1	Top only with 1/2" ground stem
-01P2	Bottom only
-01P3	Stainless steel clamp with threaded locking device
-01P4	Viton o-ring
-02	COMPLETE, 4-Part Sampler with 12 mm ground stem
-02P1	Top only with 12 mm ground stem
-02P2	Bottom only
-02P3	Stainless steel clamp with threaded locking device
-02P4	Viton o-ring

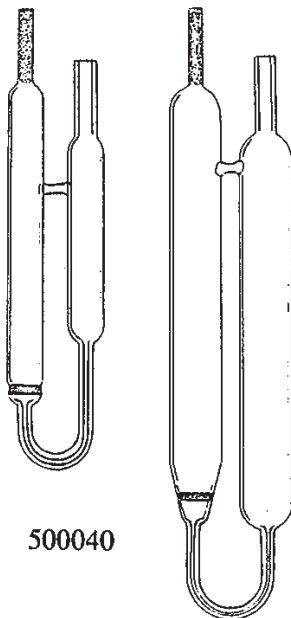

500040

## 500040

PURGE SAMPLERS. For analysis of volatile organic compounds in aqueous samples. 1/4" ground tubing and medium porosity frit.

CODE	DESCRIPTION	FORMER HGF#
-01	5 ml Sampler	018430-5
-02	25 ml Sampler	018430-25

## 500050

PURGE SAMPLERS. With 1/2" (12.7) ground tubing on the frit side of sampler and 1/4" ground tubing on the opposite side. Frits are medium porosity.

CODE	DESCRIPTION	FORMER HGF#
-01	5 ml with frit	018631-5A
-02	5 ml without frit	
-03	25 ml with frit	018631-25A
-04	25 ml without frit	

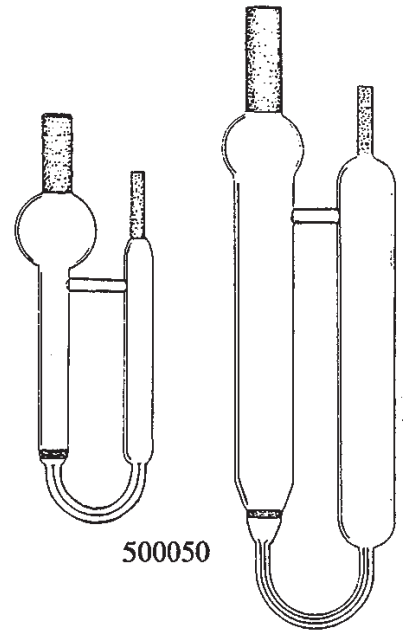

500050

## 500060

PURGE SAMPLERS. With 12 mm stem on fritted side of sampler and 1/4" on the opposite side. Frits are medium porosity and sealed in with no dead space below the frit.

CODE	DESCRIPTION	FORMER HGF#
-01	5 ml Sampler	019042-5
-02	25 ml Sampler	019042-25

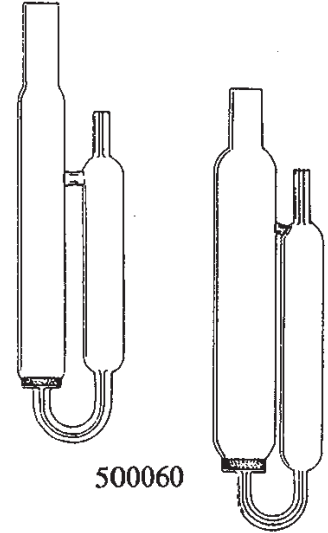

500060

## 510500

TEFLON SLEEVE. For standard taper joints minimum 3 Mil wall thickness.

CODE	§ JOINT SIZE	CODE	§ JOINT SIZE
-01	10/30	-07	29/42
-02	14/20	-08	34/45
-03	14/35	-09	45/50
-04	19/22	-10	50/50
-05	19/38	-11	55/50
-06	24/40	-12	71/60



510500

## 510600

SPRING, STAINLESS STEEL.

CODE	LENGTH
-01	3/4"
-02	1"
-03	1 1/2"
-04	2"



510600



510650

### 510650

KECK CLIPS,  $\frac{3}{8}$  joints.

CODE	COLOR	FITS JOINT SIZE
-01	BLUE	19/22, 19/38
-02	GREEN	24/25, 24/40
-03	RED	29/26, 29/42

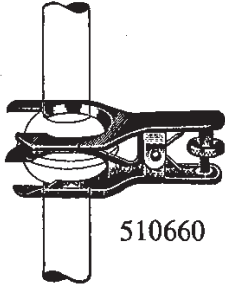

510660

### 510660

(Formerly HGF#285100)

PINCHCLAMP, STAINLESS STEEL. For use on either ball and socket or O-ring joints. Made entirely of stainless steel. Codes -01 and -03 are without screw type locking device. All other sizes have a threaded locking device.

CODE	CLAMP SIZE	CODE	CLAMP SIZE
-01	12	-06	35
-02	12-L	-07	40
-03	18	-08	50
-04	18-L	-09	65
-05	28		

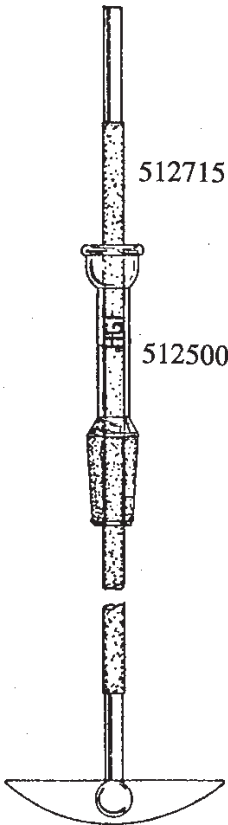

512715

512500

### 512500

STIR BEARING, PRECISION BORE. With lubricant cup and  $\frac{3}{8}$  inner ground joint. I.D. is 10 mm.

CODE	JOINT SIZE
-01	24/40
-02	29/42
-03	34/45
-04	45/50
-05	55/50

### 512715

STIR ROD, PRECISION GROUND. With blade retaining button.

CODE	O.A.L. (MM)	FITS FLASK SIZE
-01	445	250 - 3000 ml
-02	515	3000 - 5000 ml
-03	590	12,000 - 22,000 ml

## 512800

STIR BLADE, Teflon 1/8" thick.

CODE	FLASK SIZE (ML)	WIDTH & LENGTH	MINIMUM $\Phi$ CLEARANCE
-01	250 - 300	19 X 60	24/40
-02	500 - 1000	19 X 75	24/40
-03	2000 - 3000	24 X 110	29/42
-04	5000	24 X 130	29/42
-05	12,000 - 22,000	24 X 160	29/42



512800

## 525500

SULFUR DETERMINATION APPARATUS. ASTM D1266. For use in the test for sulfur in petroleum products and liquefied petroleum gases (Lamp Method).

CODE	DESCRIPTION
-01	Spray Trap
-02	Absorber
-03	Chimney
-04	Standard Burner
-05	Burner for LPG
-06	Burner for Aromatic Samples
-07	Standard Flask
-08	Flask for Aromatic Samples

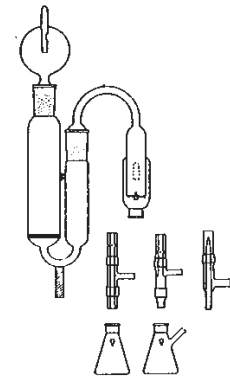

525500

## 525600

SULFUR APPARATUS, RANEY NICKEL, IMPROVED. UOP 357-76. For determination of low concentrations of sulfur in distillate stocks. Improvements consist of a Teflon stopcock plug and a glass rod brace on the funnel adapter. Flask joint is  $\Phi$  24/40 and all other joints are  $\Phi$  7/25.

CODE	DESCRIPTION
-01	Flask
-02	Funnel adapter
-03	Condenser
-04	Absorber
-05	Connecting tube for funnel adapter, plain
-06	Connecting tube for condenser, $\Phi$ 7/25

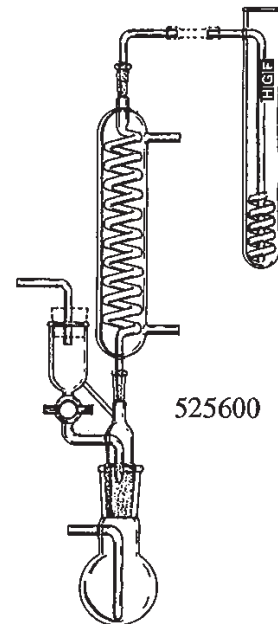

525600

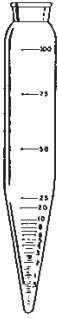

530100 530105

### 530100

TUBE, CENTRIFUGE, LONG-CONE, 100 ml. ASTM D91, D96. For use with standard methods of test for water sediment in petroleum products. Graduated 0-.5 x .05 ml, .5-2 x .1 ml, 2-3 x .2 ml, 3-5 x .5 ml, 5-10 x 1 ml, 10 - 25 x 5 ml, and at 50ml, 75, and 100 ml. Tube is approximately 37 mm O.D.

CODE

---

-01

### 530105

TUBE, CENTRIFUGE, LONG-CONE, 200%. Identical to 530100 except graduated 0 - 200%. [1 ml = 2%]

CODE

---

-01



530110 530115

### 530110

TUBE, CENTRIFUGE, SHORT-CONE, 100 ml. Similar to 530100, but shorter and wider in shape. Developed for field use in testing petroleum by ASTM D96 AND API2500. Graduations are identical to 530100. Tube is approximately 45 mm O.D.

CODE

---

-01

### 530115

TUBE, CENTRIFUGE, SHORT-CONE, 200%. Identical to 530110, except graduated 0 - 200%. [1 ml = 2%]

CODE

---

-01

## 530200

TEST tube, with rim.

CODE O.D. X LGTH (MM)

---

-01	30 X 200
-02	30 X 300
-03	32 X 200
-04	32 X 300
-05	38 X 200

(PLEASE CALL FOR A QUOTE ON OTHER SIZE REQUIREMENTS)



530200

## 530300

TEST TUBE, WAX TEST. ASTM D87. For use in the test for melting point of paraffin wax. Tube is 25 x 100 mm and has a graduation point.

CODE

---

-01



530300

## 540500

WEATHERING TUBE. For testing propane, butane and isobutane mixtures. CGNA TS441.

CODE

---

-01



540500

## 542150

(Formerly HGF#018692)

VACUUM TRAP, DEWAR TYPE. With 500 ml lower reservoir. Dry ice chamber is 70 mm I.D. x 270 mm deep.

CODE DESCRIPTION

---

-01	Vacuum Trap with 4 mm Glass stopcock
-02	Vacuum Trap with 4 mm Teflon stopcock

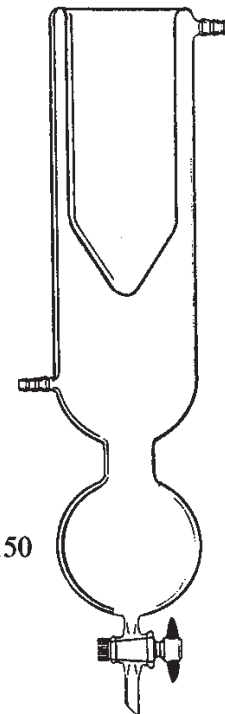

542150

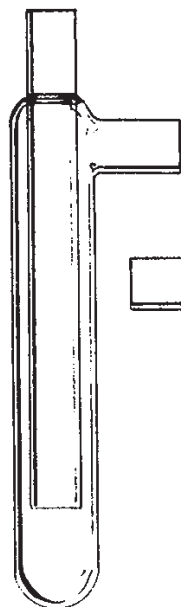

542200

### 542200

VACUUM TRAP, PLAIN. One-piece trap

CODE	BODY DIA.(MM)	BODY LGTH.(MM)	TUBE O.D. (MM)
-01	25	200	10
-02	30	225	13
-03	35	250	16
-04	38	250	20
-05	45	275	25

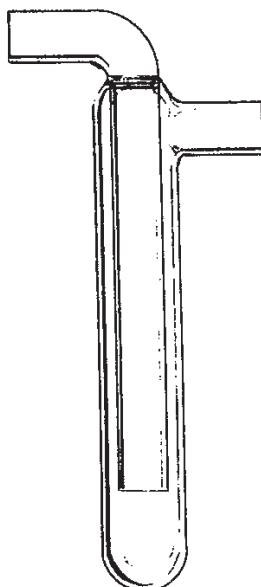

542230

### 542230

VACUUM TRAP, PLAIN. Identical to 542200, except top tube is bent at 90°.

CODE	BODY DIA. (MM)	BODY LGTH. (MM)	TUBE O.D. (MM)
-01	25	200	10
-02	30	225	13
-03	35	250	16
-04	38	250	20
-05	45	275	25

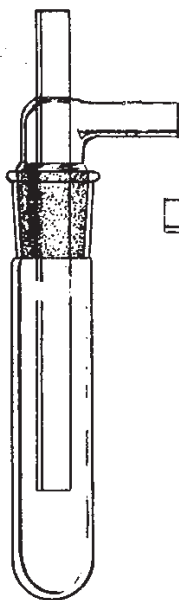

542260

### 542260

VACUUM TRAP, SEPARABLE. Two-piece trap with ground joint connection.

CODE	BODY DIA. (MM)	BODY LGTH. (MM)	TUBE O.D. (MM)	§ JOINT
-01	32	200	10	29/42
-02	38	225	13	34/45
-03	45	250	16	40/50
-04	48	250	20	45/50

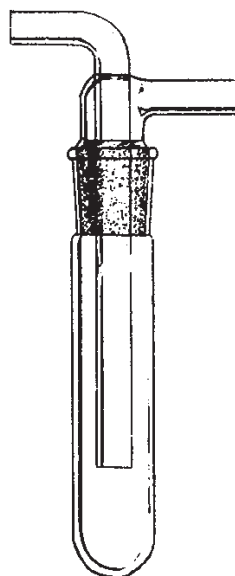

542290

### 542290

VACUUM TRAP, SEPARABLE. Identical to 542260, except top tube is bent at 90°.

CODE	BODY DIA. (MM)	BODY LGTH. (MM)	TUBE O.D. (MM)	§ JOINT
-01	32	200	10	29/42
-02	38	225	13	34/45
-03	45	250	16	40/50
-04	48	250	20	45/50

## 550100

QUARTZ COMBUSTION TUBE.

CODE	FORMER HGF#
-01	018991

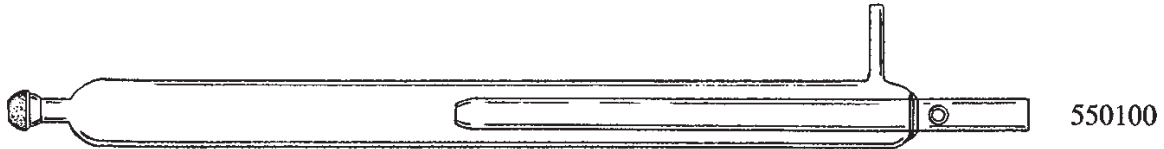

## 550150

QUARTZ COMBUSTION TUBE, SEPARABLE.

CODE	DESCRIPTION	FORMER HGF#
-00	COMPLETE 2 PC Combustion Tube with stainless steel springs	n/a
-01	Outer Tube	019049
-02	Inner Tube	019050

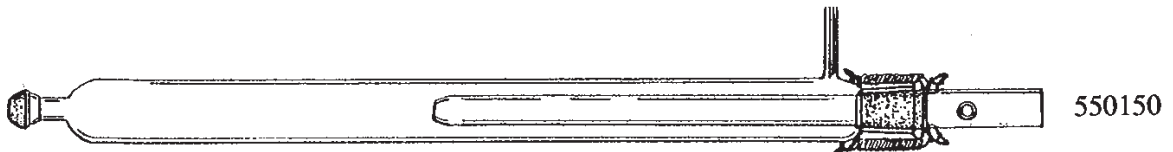

## 550200

QUARTZ COMBUSTION TUBE.

CODE	O.A.L. (MM)	X LENGTH (MM)	FORMER HGF #
-01	448	80	018356
-02	583	215	018536

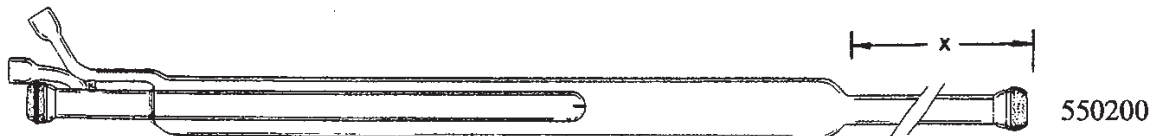

### 550300

QUARTZ COMBUSTION TUBE. 19/38 ♂ joint and 18/9 ♀.

CODE	DESCRIPTION	FORMER HGF#
-01	Combustion Tube	019064

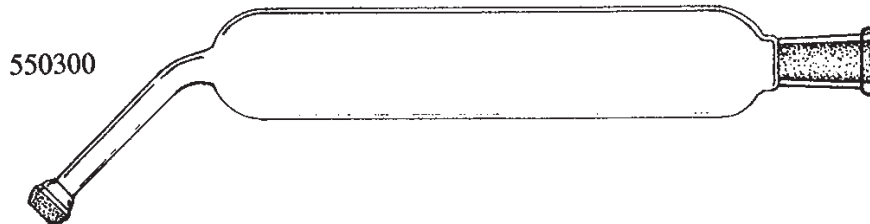

### 550400

QUARTZ FLASK ASTM D-1160. 500 ml with 35/25 ♀.

CODE	DESCRIPTION	FORMER HGF#
-01	Flask 500 ml with thermowell	210360-Q
-02	Flask 500 ml without thermowell	n/a

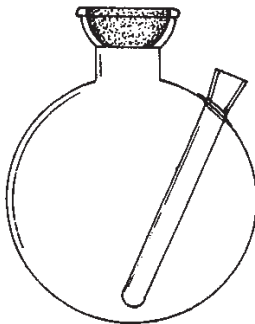

550400

### 550450

QUARTZ COMBUSTION TUBE.

CODE	DESCRIPTION	FORMER HGF#
-01	Furnace Tube, Old style 15" long	018222
-02	Furnace Tube, New style 15" long	018981



# INDEX

AASHO T78 .....	E-4	<b>BOTTLE</b>	
<b>ADAPTER</b>		Gas Washing .....	B-1,B-2
Addition Type .....	A-2	Single Neck .....	B-1
Angle 75° .....	A-2	Specific Gravity .....	B-2
Angle 105° .....	A-2	Bubbler, Midget .....	B-3
Angle 105° with drip tip .....	A-2	Bulb, Gaillard, Gas Weighing .....	B-3
Bushing Type .....	A-1	<b>BURET</b>	
Claisen .....	A-3,A-4	Acid .....	B-6
Connecting .....	A-2,A-4,A-5,A-10,A-11	Air Tester .....	B-7
Distillate Collector .....	A-5	Automatic .....	B-6,B-7
Distilling .....	A-5,A-6,A-11	Automatic Zero, Laboratory grade .....	B-4
Gas Inlet .....	A-6,A-7	Automatic, Precision .....	B-5
Gas Outlet .....	A-7	Dispensing .....	B-4
High-Vacuum .....	A-9	Gas Tutweiler .....	B-8
Hose Connector .....	A-7,A-8	Gas, Tutweiler, Teflon .....	B-8
Hose Conector , Teflon stopcock .....	A-3	Jacketed, MCA-4 .....	B-5
Hose Connector, Glass stopcock .....	A-8	Micro, Precision .....	B-4,B-5
Offset .....	A-8	Straight .....	B-4
Reducing and Enlarging .....	A-1	Tetra Ethyl Lead .....	B-7
Stopcock Outlet, Glass or Teflon .....	A-8	CGNA TS 441 .....	M-7
Straight .....	A-9	<b>COLUMN</b>	
Straight with trap .....	A-9	Adsorption, Standard, ASTM D1319 .....	C-1
Thermometer .....	A-9	Adsorption, Tru-Bore, ASTM D1319 .....	C-1
Thermometer Well .....	A-9	Analytical Adsorption, ASTM D2002 .....	C-1
Thermometer, Tef Jts .....	A-11	Chromatographic .....	C-2,C-3,C-4
Vacuum Take-Off .....	A-10,A-11	Chromatographic, Plain .....	C-1
Amott Wettability Cell, Imbition Tube .....	E-7	Drying .....	C-2
Amott Wettability Cell, Imbition Tube w/stopcock .....	E-7	Combustion Tube, Quartz .....	Q-1,Q-2
API 2500 .....	M-6	<b>CONCENTRATOR</b>	
<b>ASTM REFERENCE</b>		Evaporative, Kuderna-Danish-A .....	C-5
ASTM D-20 .....	C-1	Evaporative, Kuderna-Danish-B .....	C-5
ASTM D-87 .....	M-7	Evaporative, Kuderna-Danish-C .....	C-6
ASTM D-91 .....	M-6	Evaporative, Kuderna-Danish-D .....	C-6
ASTM D-95 .....	M-6	<b>CONCENTRATOR TUBES</b>	
ASTM D-96 .....	M-6	Graduated .....	C-7
ASTM D-123 .....	D-10	Graduated, No hooks .....	C-7
ASTM D-246 .....	E-4	Ungraduated .....	C-8
ASTM D-402 .....	E-4	Ungraduated, No hooks .....	C-8
ASTM D-721 .....	F-1	<b>CONDENSER</b>	
ASTM D-941 .....	B-2	Allihn, Jacketed, jts top and bottom .....	C-13
ASTM D-943 .....	M-1	Allihn, joint at bottom .....	C-12
ASTM D-1160 .....	D-5	Allihn, joint at top .....	C-12
ASTM D-1266 .....	M-5	Allihn, joint at top and bottom .....	C-12
ASTM D-1319 .....	C-1	Allihn, Plain .....	C-12
ASTM D-1939 .....	A-5	Asphalt .....	E-4
ASTM D-2002 .....	C-1	Dry Ice .....	C-15
ASTM D-2036 .....	F-9		
ASTM D-2041 .....	G-5		
ASTM D-2569 .....	E-4		
ASTM D-2892 .....	D-13		
ASTM E-123 .....	D-10		

# INDEX

## CONDENSER (Continued)

Friedrich .....	C-15
Graham, Jacketed, jt at top.....	C-13
Graham, Jacketed, jts at top and bottom.....	C-13
Graham, joint at bottom .....	C-10
Graham, joint at top .....	C-10
Graham, joints at top and bottom .....	C-10
Graham, Plain .....	C-10
Hopkins .....	C-14
Leibig, joint at top.....	C-9
Leibig, Plain .....	C-9
Liebig, Jacketed, jts top and bottom.....	C-13
Liebig, joint at bottom.....	C-9
Liebig, joints at top and bottom.....	C-9
Micro .....	C-8
Reflux.....	C-14,C-18
Reflux, Vacuum Jacketed .....	D-18
Solvent Recovery.....	C-8
West, joint at bottom .....	C-11
West, joint at top .....	C-11
West, Joint at top and bottom .....	C-11
West, Plain.....	C-11

## DISTILLATION APPARATUS

Hydrogen Cyanide .....	D-2
Hydrogen Sulfide .....	D-2
Petroleum.....	D-5
Phenol.....	D-6
Solvent.....	D-21

Distillation Head, Automatic, Liquid Dividing .....	D-17
---	------

## DISTILLING APPARATUS

Cyanide.....	D-1
Cyanide (125 ml).....	D-1
Iowa State .....	D-1
Kjeldahl, Micro .....	D-3
Micro .....	D-3,D-4
Reduced pressure .....	D-7
Water.....	D-5
Water, Yoe-Type.....	D-6

## DISTILLING COLUMN

Oldershaw, Bubble Plate Column.....	D-14
Oldershaw, Distillate Receivers .....	D-16,D-17
Oldershaw, Feed Section .....	D-19
Oldershaw, Random Packing .....	D-15
Plain .....	D-7,D-8
Plain, with perforated cone .....	D-7,D-8
Vigreux.....	D-8

Distilling Flask, Church.....	E-4
-------------------------------	-----

Distilling Head, Variable Reflux.....	D-8,D-9
---------------------------------------	---------

## DISTILLING RECEIVER

ADA.....	D-9
Cylindrical .....	D-11
Dean-Stark, Solvent return tube.....	D-10
Herzog Type .....	D-9
Micro .....	D-11
Moisture Test, Barrett-Type.....	D-10
Moisture Test, Barrett-Type Tef.....	D-10
Moisture Test, Dean-Stark.....	D-10
Straight-Type .....	D-12
Vacuum.....	D-9,D-11,D-12

Dithiocarbamate Apparatus .....	D-22
---------------------------------	------

EPA Methods Glassware .....	C-2,C-5,D-2,E-1
-----------------------------	-----------------

## EXTRACTION APPARATUS

Bailey-Walker.....	E-6
Dean-Stark.....	E-5
Dean-Stark, Modified .....	E-5
Liquid-Liquid.....	E-1
Off-Set Extractor, Modified .....	E-3
Soxhlet.....	E-2
Soxhlet/Dean-Stark Receiver .....	E-2
Treated Wood .....	E-4

Extraction, Thimble .....	E-3
Extractor Body.....	E-6
Extractor, Liquid-Liquid .....	E-1
Extractor, Soxhlet (Modified).....	E-2

Filter Stick Assembly.....	F-1
----------------------------	-----

## FLASK

Bailey-Walker.....	E-7
Calibrating.....	F-6
Filter.....	F-1
Five Neck.....	F-4
Four Neck .....	F-4
Kuderna-Danish.....	C-7
Quartz .....	Q-2
Reaction.....	F-5
Single Neck.....	F-2
Three Neck .....	F-3
Two Neck.....	F-3

Flask Head, Four neck.....	F-5
Flask Head, Three neck.....	F-5
Flexopulse Timer.....	D-19
Freeze Point Apparatus .....	F-9

## INDEX

### FUNNEL

Addition, Cylindrical .....	F-9
Addition, Cylindrical, Graduated .....	F-9
Buchner-Type .....	F-7
Powder .....	F-7
Powder, Off-Set .....	F-8
Separatory, Cylindrical.....	F-8
Separatory, Cylindrical, Graduated.....	F-9
Separatory, Squibb, Pear-Shaped.....	F-8

### GAS COLLECTING TUBE

Micro .....	G-2
Plain .....	G-1
Plain, with Teflon stopcocks .....	G-1
Plain, with Glass stopcocks and septum .....	G-1
Plain, with Teflon stopcocks and septum .....	G-1

Gauge, Vacuum or Pressure.....	G-5
Gauge, Vacuum, Manometer.....	G-5

### IMPINGER

Greenburg-Smith .....	G-3
Greenburg-Smith, Modified.....	G-3
Midget .....	B-3,G-2
Midget with Socket joints .....	B-3

IP 157 .....	M-1
--------------	-----

Keck Clips .....	M-4
------------------	-----

Manifold, Gas .....	G-4
Manifold, Vacuum.....	G-4

Oxidation Cell.....	M-1
---------------------	-----

Pinchclamp, Stainless Steel.....	M-4
Pipet, Automatic, Tilt-A-Matic.....	M-1
Purge Sampler .....	M-2,M-3

Reboiler, Three-Leg .....	D-20
Receiving Flask.....	E-8
Receiving Tubes .....	E-8

Sleeve, Teflon .....	M-3
Snyder Column.....	C-5, C-6
Snyder Column, Micro.....	C-7
Solenoid, Auto Liquid Dividing Heads.....	D-19
Solvent/Freon Repurification Automatic Distilling Unit.....	D-21
Sparge Sampler, Needle.....	M-1,M-2
Spring, Stainless Steel .....	M-3
Stir Bearing, Precision Bore .....	M-4
Stir Blade, Teflon.....	M-5
Stir Rod, Precision Ground .....	M-4

Sulfur Apparatus, Raney Nickel.....	M-5
Sulfur Determination Apparatus.....	M-5

Test Tube.....	M-7
Test Tube, Wax Test.....	M-7
Thermocouple Adapter .....	D-20

### TUBE

Centrifuge, Long Cone .....	M-6
Centrifuge, Long Cone 200% .....	M-6
Centrifuge, Short Cone.....	M-6
Centrifuge, Short Cone 200% .....	M-6
Weathering .....	M-7

UOP 9-59 .....	B-8
UOP 325 .....	C-1
UOP 357-76 .....	M-5

### VACUUM TRAP

Dewar Type .....	M-7
Plain.....	M-8
Separable .....	M-8